

EPSON

RC170 / RC180 Option
Teach Pendant

TP1

Rev.7

EM105P2032F

RC170 / RC180 Option Teach Pendant TP1 Rev.7

RC170 / RC180 Option
Teach Pendant

TP1

Rev.7

Copyright © 2006-2010 SEIKO EPSON CORPORATION. All rights reserved.

FOREWORD

Thank you for purchasing our robot products.

This manual contains the information necessary for the correct use of the Teach Pendant.

Please carefully read this manual and other related manuals before installing the robot system.

Keep this manual handy for easy access at all times.

WARRANTY

The robot system and its optional parts are shipped to our customers only after being subjected to the strictest quality controls, tests, and inspections to certify its compliance with our high performance standards.

Product malfunctions resulting from normal handling or operation will be repaired free of charge during the normal warranty period. (Please ask your Regional Sales Office for warranty period information.)

However, customers will be charged for repairs in the following cases (even if they occur during the warranty period):

1. Damage or malfunction caused by improper use which is not described in the manual, or careless use.
2. Malfunctions caused by customers' unauthorized disassembly.
3. Damage due to improper adjustments or unauthorized repair attempts.
4. Damage caused by natural disasters such as earthquake, flood, etc.

Warnings, Cautions, Usage:

1. If the robot system associated equipment is used outside of the usage conditions and product specifications described in the manuals, this warranty is void.
2. If you do not follow the WARNINGS and CAUTIONS in this manual, we cannot be responsible for any malfunction or accident, even if the result is injury or death.
3. We cannot foresee all possible dangers and consequences. Therefore, this manual cannot warn the user of all possible hazards.

TRADEMARKS

Microsoft, Windows, and Windows logo are either registered trademarks or trademarks of Microsoft Corporation in the United States and/or other countries. Other brand and product names are trademarks or registered trademarks of the respective holders.

TRADEMARK NOTATION IN THIS MANUAL

Microsoft® Windows® XP Operating system

Microsoft® Windows® Vista Operating system

Throughout this manual, Windows XP, and Windows Vista refer to above respective operating systems. In some cases, Windows refers generically to Windows XP, and Windows Vista.

NOTICE

No part of this manual may be copied or reproduced without authorization.

The contents of this manual are subject to change without notice.

Please notify us if you should find any errors in this manual or if you have any comments regarding its contents.

INQUIRIES

Contact the following service center for robot repairs, inspections or adjustments.

If service center information is not indicated below, please contact the supplier office for your region.

Please prepare the following items before you contact us.

- Your controller model and its serial number
- Your manipulator model and its serial number
- Software and its version in your robot system
- A description of the problem

SERVICE CENTER

--

MANUFACTURER & SUPPLIER

Japan & Others

SEIKO EPSON CORPORATION

Suwa Minami Plant
Factory Automation Systems Dept.
1010 Fujimi, Fujimi-machi,
Suwa-gun, Nagano, 399-0295
JAPAN
TEL : +81-(0)266-61-1802
FAX : +81-(0)266-61-1846

SUPPLIERS

North & South America

EPSON AMERICA, INC.

Factory Automation/Robotics
18300 Central Avenue
Carson, CA 90746
USA
TEL : +1-562-290-5900
FAX : +1-562-290-5999
E-MAIL : info@robots.epson.com



Europe

EPSON DEUTSCHLAND GmbH

Factory Automation Division
Otto-Hahn-Str.4
D-40670 Meerbusch
Germany
TEL : +49-(0)-2159-538-1391
FAX : +49-(0)-2159-538-3170
E-MAIL : robot.infos@epson.de

Before Reading This Manual

Following descriptions are indicated throughout the manual by these symbols.

 <p>NOTE</p>	The “NOTE” sections describe important information to be followed for operating the Robot system.
 <p>TIP</p>	The “TIP” sections describe hints for easier or alternative operations.

 NOTE Do not connect the TP1 to following Robot Controllers. Connecting to following Robot Controllers may result in malfunction of the device since the pin assignments are different.
RC420 / RC520 / SRC5** / SRC-3** / SRC-2**

 NOTE A coordinate point including the arm pose is defined as “position (point),” and the data is called “point data.”

TABLE OF CONTENTS

Functions & Installation

1	Safety	3
1.1	Conventions.....	3
1.2	Safety Precautions	3
1.3	EMERGENCY STOP.....	7
1.4	Mode Selector Key Switch.....	8
1.5	Using Teach Pendant in Safeguarded Area	8
2	Specifications	9
2.1	Part Names and Functions	9
2.2	Standard Specifications.....	11
2.3	Outer Dimensions.....	11
3	Installation	12
3.1	Contents	12
3.2	Environmental Conditions.....	12
3.3	Operating Precautions.....	12
3.4	Connection	13
3.4.1	Typical cable connection.....	13
3.4.2	Connection to the Controller	14
3.4.3	Operator Panel Connection.....	14
3.5	Power Supply	15
3.6	Wall Bracket (Option)	16
4	Operation Mode (TEACH/AUTO)	18
4.1	Outline	18
4.2	Switch Operation Mode	19
5	Operation Panel (Key Description)	20
6	Enable Switch	23

Operation

1 Teaching Procedure	27
1.1 Jog Operation	27
1.2 Teaching	28
1.3 Direct Teaching	29
2 TEACH Mode	31
2.1 [Jog & Teach].....	32
2.1.1 Specifying Point No.	32
2.1.2 Specifying Jog Mode	32
2.1.3 Specifying Jog Speed.....	33
2.1.4 Executing Step Jog	33
2.1.5 Executing Continuous Jog.....	33
2.1.6 ON/OFF	33
2.1.7 Motor ON/OFF.....	34
2.1.8 Executing Return to Home	34
2.1.9 Teaching.....	34
2.1.10 Saving Point Data to File	35
2.1.11 Loading Point Data from File	35
2.2 Editing Points	36
2.2.1 Specifying Point No.	36
2.2.2 Changing Point Label	36
2.2.3 Changing Coordinate Data and Pose Flag	36
2.2.4 Deleting Point Data	36
2.3 Changing Jog Distance Data	37
2.3.1 Changing Distance Data.....	37
2.3.2 Return Data to Defaults	37
2.4 Arm/Tool/Local/ECP	38
2.4.1 Changing Arm No.	38
2.4.2 Changing Tool No.	38
2.4.3 Changing Local No.	38
2.4.4 Changing ECP No.	38
2.5 Executing I/O Commands	39
2.5.1 Switching Input/Output Status Display	39
2.5.2 Output Bit ON/OFF	39
2.6 Executing Motion Commands	40
2.6.1 E2 Series / G Series / RS Series.....	40
2.6.2 PS Series	40

2.7	Calibrating Origin : E2 Series / G Series / RS Series	41
2.7.1	Calibration Procedures (E2 Series).....	42
2.7.2	Calibration Procedures (G Series / RS Series).....	50
2.7.3	Setting Righty / Lefty (E2 Series / G Series).....	59
2.8	Calibrating Origin : PS Series	62
2.9	Releasing Brake (PS series only).....	68
3	AUTO Mode	70
3.1	Program Command Display.....	72
3.2	I/O Monitor.....	73
3.3	Memory I/O Monitor.....	73
3.4	Task Monitor.....	74
3.5	System History	75
3.6	Program Mode.....	76
3.6.1	Open Programs.....	77
3.6.2	Building Projects	83
3.6.3	Backing up Projects	84
3.6.4	Restore Projects	85
3.6.5	Import Files	86
3.6.6	Export Files.....	87
3.6.7	Backup System	89
3.6.8	Restore System	91
3.6.9	Changing Speed Factor	93
3.6.10	Configuration.....	93
3.6.11	Change Display Language.....	95
3.6.12	Update System Software	96
3.7	Backup / Restore	98
3.8	Save Controller Statuses.....	99
3.9	Display Date and Time	99
3.10	Adjust Brightness and Contrast	100
3.11	Error Messages	100
4	Password Setup	101
5	Troubleshooting	102
6	Maintenance Parts List and Option	103



Functions & Installation

This section contains information about functions and installation of the Teach Pendant to be known before operation and maintenance.

1. Safety

1.1 Conventions

Important safety considerations are indicated throughout the manual by the following symbols. Be sure to read the descriptions shown with each symbol.

 WARNING	This symbol indicates that a danger of possible serious injury or death exists if the associated instructions are not followed properly.
 WARNING	This symbol indicates that a danger of possible harm to people caused by electric shock exists if the associated instructions are not followed properly.
 CAUTION	This symbol indicates that a danger of possible harm to people or physical damage to equipment and facilities exists if the associated instructions are not followed properly.

1.2 Safety Precautions

For details of Safety, refer to *Safety* Chapter in the *User's Guide*. Please read and understand the chapter before using the robot system.

 WARNING	<ul style="list-style-type: none"> ■ Only trained personnel should design and install the robot system. Trained personnel are defined as those who have taken robot system training and maintenance training classes held by the manufacturer, dealer, or local representative company, or those who understand the manuals thoroughly and have the same knowledge and skill level as those who have completed the training courses. ■ Only authorized personnel who have taken the safety training should be allowed to execute teaching or calibration of the robot system. The safety training is the program for industrial robot operator that follows the laws and regulations of each nation. The personnel who have taken the safety training acquire knowledge of industrial robots (operations, teaching, etc.). The personnel who have completed the robot system-training class held by the manufacturer, dealer, or locally-incorporated company are allowed to maintain the robot system.
--	---

 WARNING	<ul style="list-style-type: none"> <p>■ Only authorized personnel who have taken the safety training should be allowed to maintain the robot system.</p> <p>The safety training is the program for industrial robot operator that follows the laws and regulations of each nation. The personnel who have taken the safety training acquire knowledge of industrial robots (operations, teaching, etc.), knowledge of inspections, and knowledge of related rules/regulations. The personnel who have completed the robot system-training and maintenance-training classes held by the manufacturer, dealer, or locally incorporated company are allowed to maintain the robot system.</p> <p>■ Immediately press the EMERGENCY STOP switch whenever you suspect any danger.</p> <p>The Teach Pendant is equipped with an EMERGENCY STOP switch. Before operating the Teach Pendant, make sure that the EMERGENCY STOP switch on the Teach Pendant functions properly. Operating the Teach Pendant when the switch does not function properly is extremely hazardous and may result in serious bodily injury and/or serious damage to the equipment, as the switch cannot fulfill its intended function in an emergency.</p> <p>When nothing appears on its display window, the Teach Pendant is not connected with the Controller. In this case, the EMERGENCY STOP switch on the Teach Pendant will not function.</p> <p>■ If the Teach Pendant is not connected to the controller, DO NOT place it within easy reach during operation. You might press the EMERGENCY STOP switch on the unconnected Teach Pendant by mistake to stop the robot system in an emergency. Pressing the EMERGENCY STOP switch on the disconnected Teach Pendant in an emergency is extremely hazardous and may cause serious safety problems.</p> <p>■ When entering the safeguarded area for teaching, change the mode of the Teach Pendant to TEACH and take out the key for the mode selector key switch and then enter the safeguarded area with the key. Leaving the key in the mode selector key switch is extremely hazardous and may cause serious safety problems as someone else may inadvertently change the mode to the automatic operation.</p>
--	---

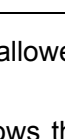
 WARNING	<ul style="list-style-type: none"> <p>■ Be sure to connect the cables between the Controller and the Teach Pendant properly. Do not allow unnecessary strain on the cables. (Do not put heavy objects on the cables. Do not bend or pull the cables forcibly.) The unnecessary strain on the cables may result in damage to the cables, disconnection, and/or contact failure. Damaged cables, disconnection, or contact failure is extremely hazardous and may result in electric shock and/or improper function of the system. Do not use the cables near heat or fire.</p>
--	--

 CAUTION	<ul style="list-style-type: none"> ■ Do not shock the Teach Pendant physically or place any object on Teach Pendant. A liquid crystal display is used for the Teach Pendant display. If the display is damaged, liquid crystal may leak out. Liquid crystal is harmful. If it sticks on your skin or clothes, immediately wash your skin and clothes thoroughly with clean water and soap immediately. ■ The Teach Pendant must be used within the environmental conditions described in this manual. This product has been designed and manufactured strictly for use in a normal indoor environment. Using this product in the environment that exceeds the conditions may not only shorten the life cycle of the product but also cause serious safety problems. ■ Do not disassemble, repair, or modify the Teach Pendant by yourself. Improper disassembly, repair, or modification of the Teach Pendant may cause not only improper function of the robot system but also serious safety problems.
---	---

Safety-related Requirements

Specific tolerances and operating conditions for safety are contained in the manuals for the robot, controller and other devices. Be sure to read those manuals as well.

Robot systems safety standard and other examples are given in this chapter. Therefore, to ensure that safety measures are complete, please refer to the other standards listed as well.

(Note: The following is only a partial list of the necessary safety standards.)

EN 61000-6-2	Electromagnetic compatibility (EMC). Generic standards. Immunity standard for industrial environments
EN 61000-6-4	Electromagnetic compatibility (EMC). Generic standards. Emission standard for industrial environments
IEC 61131-2	Programmable controllers - Part 2: Equipment requirements and tests
EN ISO 12100-1	Safety of machinery - Basic concepts, general principles for design -- Part 1: Basic terminology, methodology
EN ISO 12100-2	Safety of machinery - Basic concepts, general principles for design -- Part 2: Technical principles
EN 418	Safety of machinery - Emergency stop equipment, functional aspects - principles for design
EN 614-1	Safety of machinery - Ergonomic design principles; part 1: terminology and general principles
EN 894-1	Safety of machinery - Ergonomics requirements for the design of displays and control actuators; Part 1: General principles for human interactions with displays and control actuators
EN 894-2	Safety of machinery - Ergonomics requirements for the design of displays and control actuators; Part 2: Displays

EN 894-3	Safety of machinery - Ergonomics requirements for the design of displays and control actuators - Part 3: Control actuators
EN 954-1 (ISO 13849-1)	Safety of machinery - Safety-related parts of control systems -- Part 1: General principles for design
EN 60204-1	Safety of machinery. Electrical equipment of machines. General requirements
UL 508 (=CSA C22.2 No.14)	Industrial Control Panels
EN 50178	Electronic equipment for use in power installations
EN 61131-1 (IEC1131-1)	Programmable controllers - Part 1: General information
EN 61131-2 (IEC1131-2)	Programmable controllers; part 2: equipment requirements and tests
UL 1740	Industrial robots and robotic equipment
ANSI/RIA R15.06, (=CSA-Z434-94)	American National Standard; Industrial Robots and Robot Systems - Safety Requirements
ISO 11161	Industrial automation systems - Safety of integrated manufacturing systems - Basic requirements
EN 12417	Machine tools. Safety. Machining centers
EN 14070	Safety of machine tools - Transfer and special-purpose machines.

1.3 EMERGENCY STOP



- Immediately press the EMERGENCY STOP switch whenever you suspect any danger. The Teach Pendant is equipped with an EMERGENCY STOP switch. Before operating the Teach Pendant, make sure that the EMERGENCY STOP switch on the Teach Pendant functions properly. Operating the Teach Pendant when the switch does not function properly is extremely hazardous and may result in serious bodily injury and/or serious damage to the equipment, as the switch cannot fulfill its intended function in an emergency.
When nothing appears on its display window, the Teach Pendant is not connected with the Controller. In this case, the EMERGENCY STOP switch on the Teach Pendant will not function.

When the EMERGENCY STOP switch is pushed, stops the programs execution and halts the robot excitation. Programs and point data will not be damaged.

When pushed, the EMERGENCY STOP switch mechanically holds that state and electrically holds the emergency stop state.

Reset EMERGENCY STOP

Follow these steps to reset Emergency Stop condition.

- (1) Remove the cause of the Emergency Stop and verify that it is safe to operate the robot again.
- (2) Release the EMERGENCY STOP switch. To release the mechanical latch, turn the EMERGENCY STOP switch to the right.
- (3) Turn the Teach Pendant mode selector key switch to “Teach”.
- (4) Press the <Reset> key on the operation panel to reset the Emergency Stop.
- (5) Make sure that the E-STOP lamp on the operation panel is OFF.

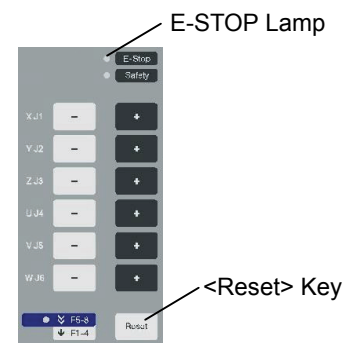

1.4 Mode Selector Key Switch

The mode selector key switch is used to select TEACH or AUTO operation mode. For safety, if the mode is changed during program execution, all tasks will be stopped.

Mode switching during task execution

AUTO → TEACH

- (1) Press the <Stop> button to stop all tasks normally.
- (2) Turn the mode selector key switch to “Teach”.

TEACH → AUTO

Turn the mode selector key switch to “Auto” and close the latch release input.

1.5 Using Teach Pendant in Safeguarded Area

When the mode selector switch of the Teach Pendant is switched to “Teach” mode, the operator can jog and move the robot to predefined points in slow speed when the enable switch is gripped and the safeguard is open.

Personnel that will be using the Teach Pendant should be thoroughly trained on how to use it.

Follow these guidelines when using the Teach Pendant in the safeguarded area:

- (1) Before entering the safeguarded area to use the Teach Pendant, turn the mode selector key switch to “Teach”.
- (2) Enter the safeguarded area and perform the teaching operations.
- (3) Leave the safeguarded area and close the safeguard.
- (4) Return the mode selector key switch to “Auto”.
- (5) Close the latch release input. (For details on the pin assignments of the EMERGENCY connector, refer to *Setup & Operation 9.3 Pin Assignments* in the RC170 / RC180 controller manual.)

2. Specifications

2.1 Part Names and Functions

Front view

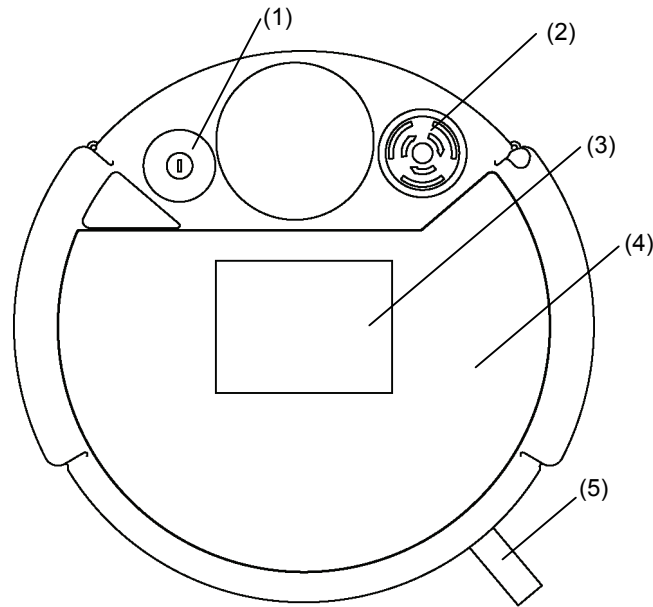

Back view

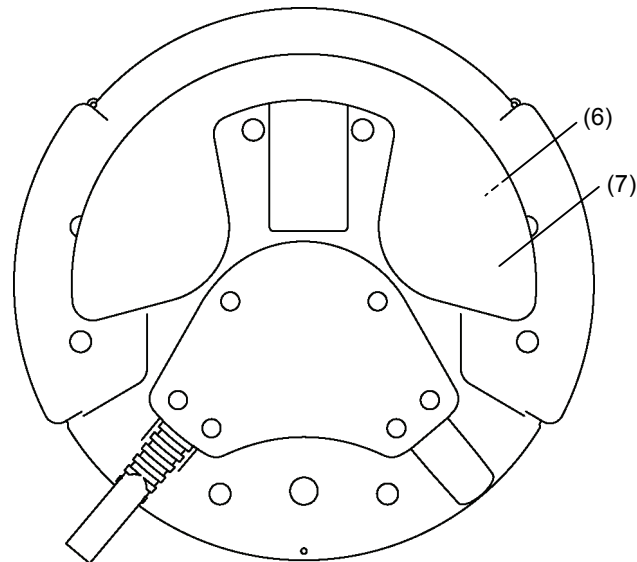

(1) Mode Selector Key switch

The mode selector key switch is used to change the operation mode between TEACH and AUTO. The mode can be fixed by pulling out the key. When the mode is switched while a program is executing, the program will be stopped.

Close the latch when switching the mode from TEACH to AUTO.

For the procedure to switch the mode, refer to *Setup & Operation 1.4 Mode Selector Key Switch*.

(2) EMERGENCY STOP switch

When this switch is pushed, the Emergency Stop state is held both mechanically and electrically. Pushing the switch stops the program, removes power to robot motors and stops the manipulator motion immediately.

To cancel the Emergency Stop state, first turn the EMERGENCY STOP switch to the right to release the mechanical latch. Switch the mode selector key switch to "Teach". Press the <Reset> key to reset the electrically held Emergency Stop state. The E-STOP lamp goes OFF.

For the procedure to reset the EMERGENCY STOP switch, refer to *Setup & Operation 1.3 EMERGENCY STOP*.

(3) Display

Displays various kinds of information.

(4) Operation Panel

Teaching operation, automatic operation and data input are available.

(5) Connection Cable

This is a cable to connect the Teach Pendant and the Controller.

The connector is attached at the end of the cable.

(6) Enable switch

This is a three-position switch. Motion and I/O output commands are available while the switch is gripped when the Teach Pendant is operated in TEACH mode. The switch turns ON when it is at the midpoint, and it turns OFF when it is fully gripped or released.

(7) Handle

Use this part as the hand strap while operating the Teach Pendant.

2.2 Standard Specifications

Item		Specification
General specifications	Rated voltage	DC24 V
	Electric power consumption	6 W or less
	Weight	1075 g (include EMERGENCY STOP switch and the mode selector key switch, excluding cables)
Display specifications	Display element	F-STN type Black and white LCD
	Contrast	8-level (Gray scale)
	Back light	LED (Color : White)
Serial interface specifications	Electrical characteristics	Compliant with RS-422A standard

2.3 Outer Dimensions

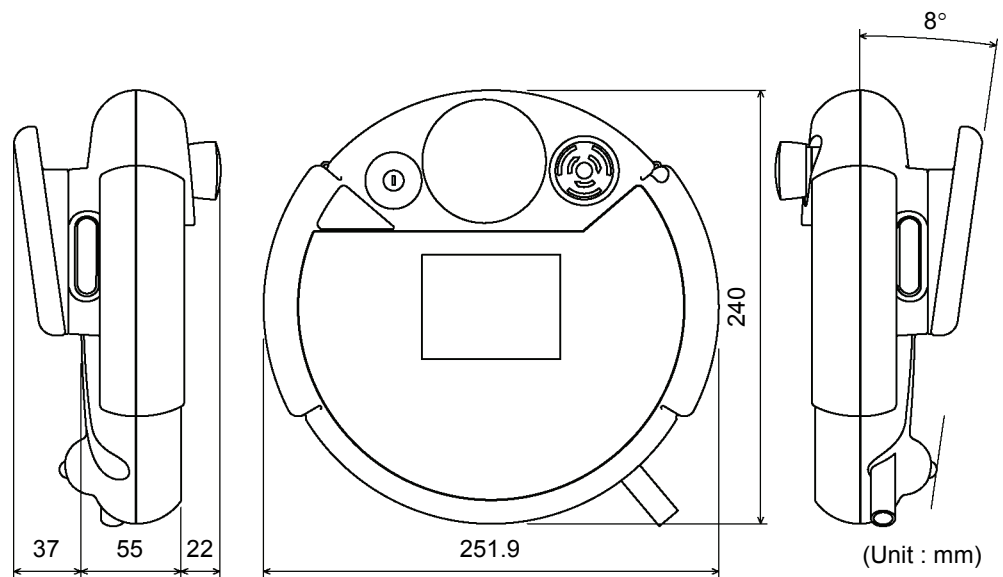

NOTE

Use the installation metal in the attachment when attaching the Teach Pendant to a panel, or the like.

3. Installation

3.1 Contents

- TP1 (with cables) : 1 unit
- Mode selector key : 2 units

3.2 Environmental Conditions

The Teach Pendant must be used in an environment that conforms to the following requirements to ensure safe and reliable operation.

Item	Condition
Ambient temperature	0 to 50 deg C (with minimal variation)
Ambient relative temperature	5 to 95%
Protection structure	IP65 (excluding the connector)
Environment	<ul style="list-style-type: none"> - Keep away from dust, oily smoke, salinity, metal powder and other contaminants. - Keep away from flammable or corrosive solvents and gases.

3.3 Operating Precautions

 CAUTION	<ul style="list-style-type: none"> ■ Do not drop the Teach Pendant or hit hard against other objects to avoid damage, as the case of the Teach Pendant may be damaged since the main body is made of resin. ■ Use the hand strap to prevent dropping the Teach Pendant during operation. ■ Do not hit the touch panel of the Teach Pendant against a hard object or put excessive pressure on it. The touch panel is made of glass. Therefore, if excessive pressure is put on it, it may be damaged. ■ Do not press or rub the surface of the front panel push buttons with a hard object such as a tool. The surface of the buttons may be damaged as they are easily scratched. ■ Wipe the dirt and oils adhering to the surface of the Teach Pendant display with a soft cloth dampened with a neutral detergent or an alcohol solvent. ■ If using the mounting bracket, check that the bracket and screws are not bent or loosened.
--	--

3.4 Connection

This section indicates the connection of the Controller and the Teach Pendant.



- Be sure to connect the cables of Controller and Teach Pendant properly. Do not allow unnecessary strain on the cables. (Do not put heavy objects on the cables. Do not bend or pull the cables forcibly.) The unnecessary strain on the cables may result in damage to the cables, disconnection, and/or contact failure. Damaged cables, disconnection, or contact failure is extremely hazardous and may result in improper function of the system.
- Make sure that the pins are not bent when connecting the connector. Connecting the connector with the pin bent may cause malfunction and result in improper function of the system.
- The connector connected to the end of the cable is a general-purpose type connector. When connecting the connector, note that the waterproof efficiency and dustproof efficiency of the connector do not comply with IP65.
- When connecting the Teach Pendant TP1 to the TP port, be careful of the connector inserting direction (up/down). It may cause malfunction and result in improper function of the system.

3.4.1 Typical cable connection

The Teach Pendant and the Operator Panel is connected to TP/OP port of controller.



When nothing is connected to the TP/OP port, Emergency Stop status occurs to the Controller. When the Teach Pendant or the Operator Panel is not connected, connect the TP/OP bypass plug.

Example

A: Only using Teach Pendant (TP Cable A)

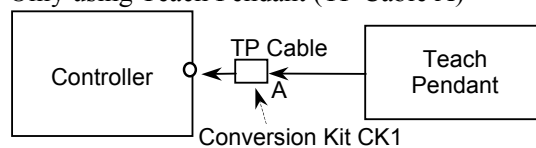

B: Only using Teach Pendant (TP Cable B)

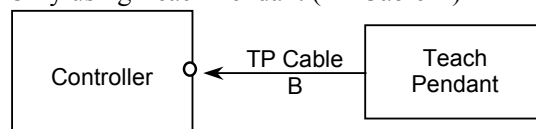

C: Only using Operator Panel

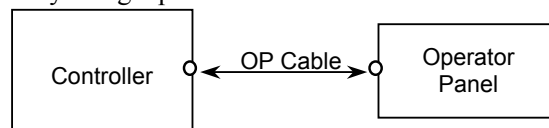

D: Using Teach Pendant and Operator Panel

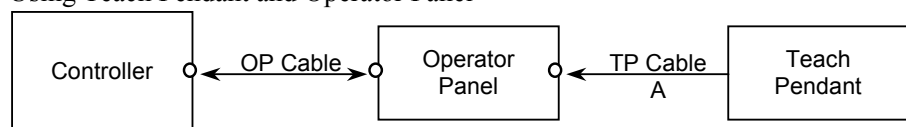

NOTE



- The shape of the cable connector used in connection A and D differs to connection B.

TP Cable A : Circular connector to connect to the Operator Panel.

(Direct connection is available with conversion kit CK1.)

TP Cable B : D-sub connector to connect directly to the Controller.

- When Teach Pendant with Operator Panel cable is inserted to the TP port of the Operator Panel, both Operator Panel and Teach Pendant are available. (Connection D)

- Do not connect TP1 to the following Robot Controllers. Connecting to the following Robot Controllers may result in malfunction of the device since the pin assignments are different.

RC420 / RC520 / SRC5** / SRC-3** / SRC-2**

3.4.2 Connection to the Controller

- (1) Make sure that the Controller and the Robot is connected properly.
- (2) Connect the connector of the Teach Pendant cable to the TP/OP port of Controller.
- (3) Turn ON the controller.

NOTE



- Teach Pendant insert and removal from the Controller are available when the Controller power is ON.

- When Teach Pendant connector is removed from the Controller with the mode selector key switch of Teach Pendant that is in “Teach” position, the operation mode will remain in TEACH mode. The operation mode cannot be switched to AUTO mode. Make sure to remove the Teach Pendant after switching the operation mode to “Auto” mode.

3.4.3 Operator Panel Connection

- (1) Make sure that the Controller and the Robot is connected properly.
- (2) Connect the connector of the Operator Panel to the TP/OP port of Controller.
- (3) Turn ON the Controller.
- (4) Connect the connector of Teach Pendant to the Operator Panel.

NOTE



- Teach Pendant insert and removal from the Controller are available when the Controller power is ON.

Make sure that the Controller is turned OFF when inserting or removing the Operator Panel.

- When Teach Pendant connector is removed from the Controller with the mode selector key switch of Teach Pendant that is in “Teach” position, the operation mode will remain in TEACH mode. The operation mode cannot be switched to AUTO mode. Make sure to remove the Teach Pendant after switching the operation mode to “Auto” mode.

3.6 Wall Bracket (Option)

Outer Dimension

[Unit :mm]

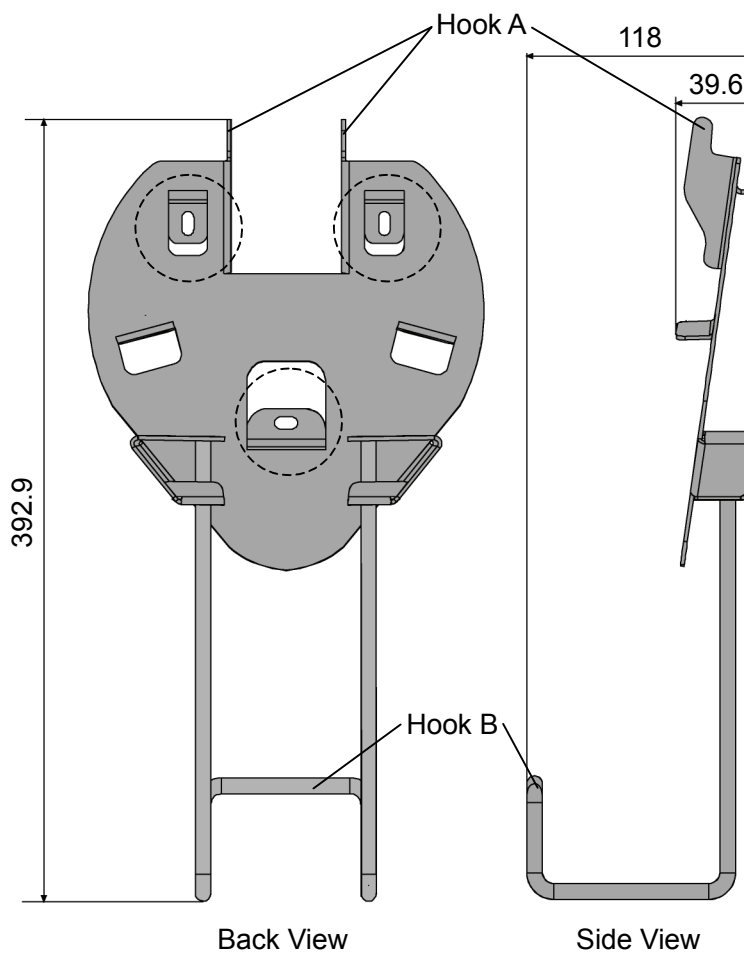
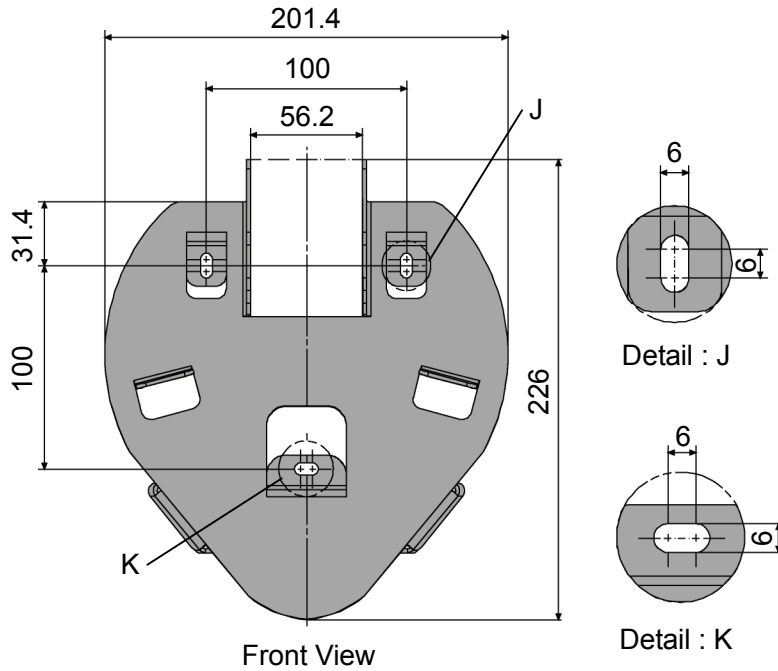

Mount and Use

Mount the Teach Pendant with the wall bracket in the following procedures.

- (1) Secure the wall bracket to the wall with three screws (positions are indicated by dotted line in the *Outer Dimension*).
- (2) Hang the handle of the Teach Pendant to Hook A.
- (3) Hang the cable of the Teach Pendant to Hook B.

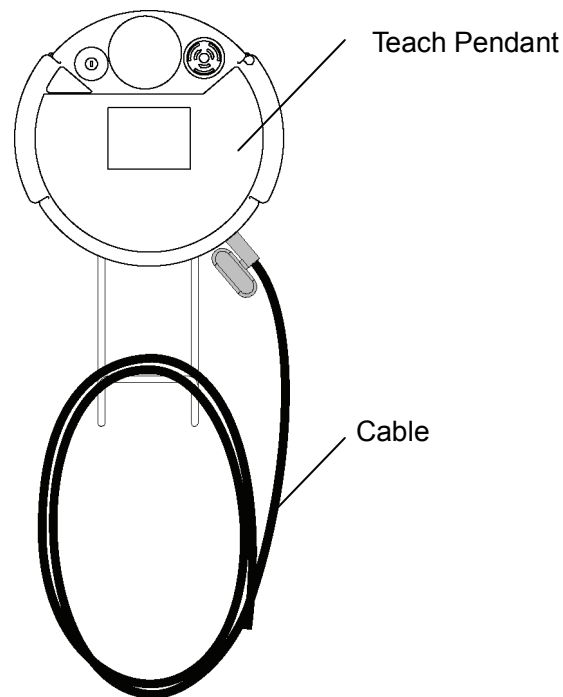

4. Operation Mode (TEACH/AUTO)

NOTE A coordinate point including the arm pose is defined as “position (point),” and the data is called “point data.”

4.1 Outline

Robot system has two operation modes TEACH mode and AUTO mode.

TEACH mode This mode enables point data teaching and check close from the Robot using the Teach Pendant.
 Robot operates in Low power status.

AUTO mode This mode enables automatic operation (program execution) of the Robot system at the manufacture operation, besides, programming, debug, adjustment, and maintenance of the Robot system.
 This mode cannot operate Robots or run program with the Safety Door open.

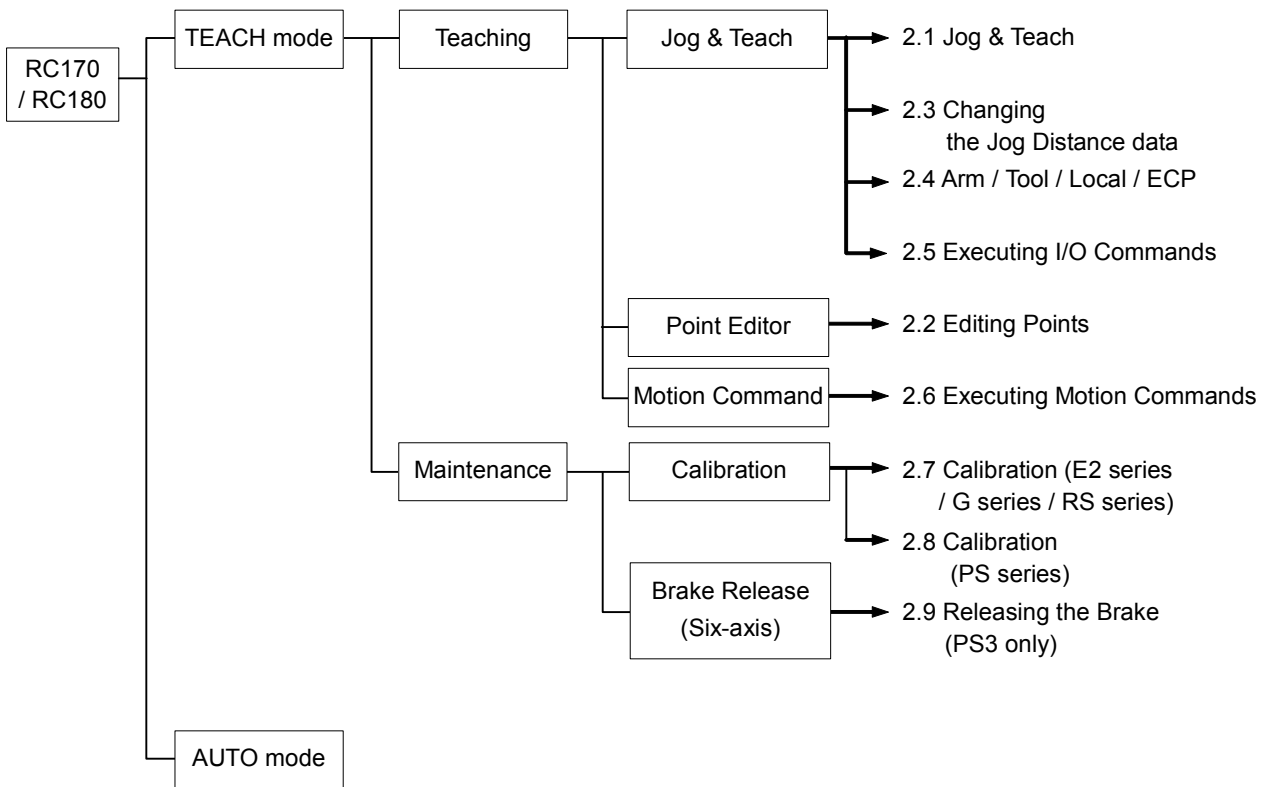

4.2 Switch Operation Mode

Change the TEACH mode and AUTO mode with the mode selector key switch on the Teach Pendant.

- | | |
|------------|--|
| TEACH mode | Turn the mode selector key switch to “Teach” for TEACH mode.
Pauses the executing program when operation mode is switched to TEACH mode.
The operating Robot stops by Quick Pause. |
| AUTO mode | Turn the mode selector key switch to “Auto” and change the latch release input signal to ON position for AUTO mode. |

5. Operation Panel (Key Description)

Key Description

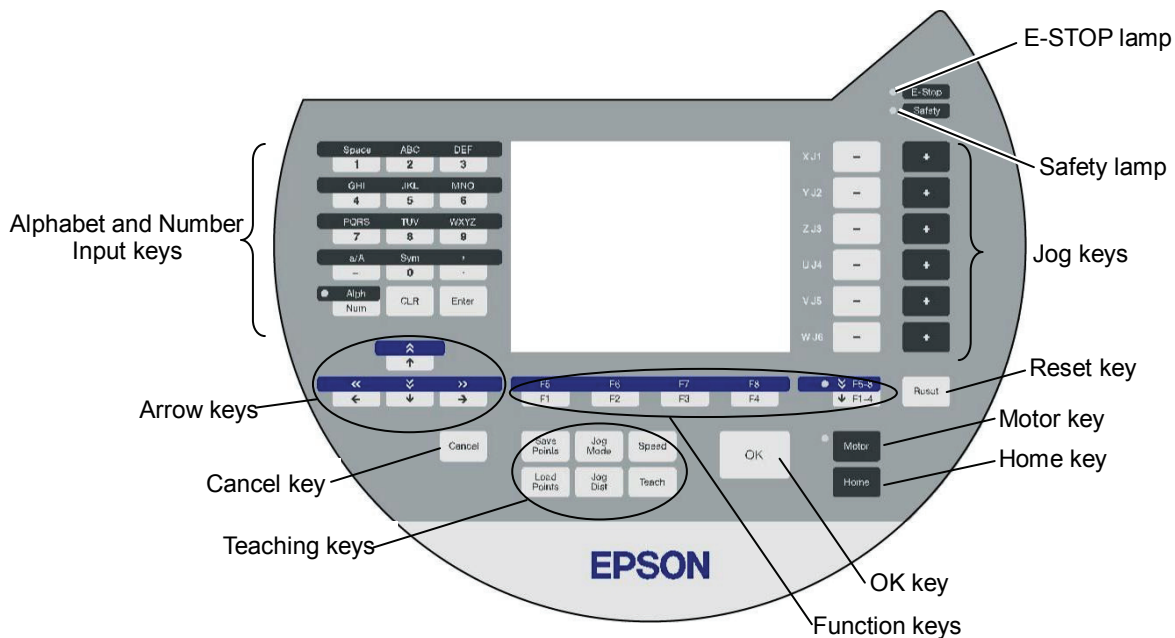

Alphabet and Number Input Keys

Input mode alphabet/number switches by turning ON/OFF the “Alph” lamp.
 Press the <Alph/Num> key to turn ON/OFF the “Alph” lamp.

Alph	Mode	Key	Function
OFF	Number input mode	From 0 to 9 - (minus) .(period)	Number input
ON	Alphabet input mode	ABC to WXYZ	Alphabet input
		SP (space)	Space input
		a/A	Case selector
		Sym	Symbol input
Common		CLR	Clear number and alphabet
		Enter	Set number and alphabet

Jog Keys

Jog key is available only in TEACH mode.

Key	Function
-	Move the target joint (X to W, J1 to J6) to - direction
+	Move the target joint (X to W, J1 to J6) to + direction

Teaching Keys

Teaching key is available only in TEACH mode.

Key	Function
Save Points	Save the point data to a file
Load Points	Read the point data from a file
Jog Mode	Specify the Jog mode
Jog Dist	Specify the Jog distance
Speed	Specify the Jog speed
Teach	Save the current position data

Other keys

Key	Function
Cancel	Cancel the setting and go back to the previous screen
OK	Save the setting and move on to the next screen
Reset	Set the initial setup status
Motor*, **	Switch the motor power ON/OFF
Home*	Move the robot to home position

* Keys with this mark are available only in TEACH mode.

** For RC180-UL, the enable switch must be turned on.

Lamp

Lamp	Function
E-Stop	Turns ON when the EMERGENCY STOP switch is pressed
Safety	Turns ON when the safeguard is open

6. Enable Switch

In TEACH mode, several operations require use of the 3-position enable switch located on the left rear of the pendant. The enable switch can be operated either hand.

When the enable switch is required to execute an operation, you must grip the switch to the center (enable) position. To do this, pull the switch with the left hand fingers until it just stops at the center detent. If you pull harder, or let go, then the switch will be disengaged and the operation will be canceled.

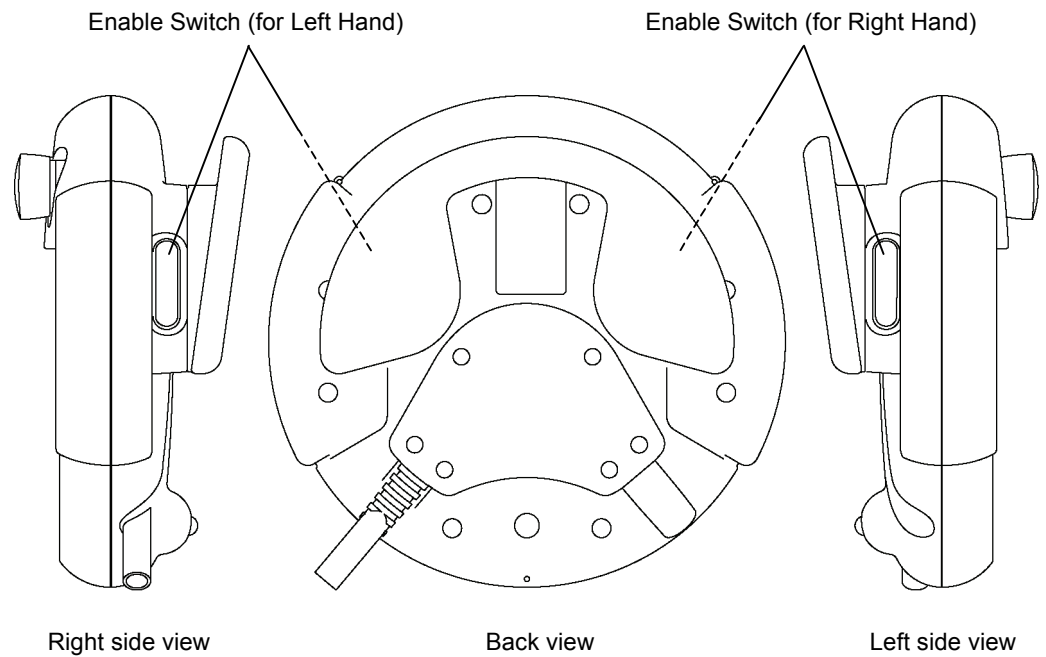

For RC180-UL

When the enable switch is off, the manipulator is in Motor Off status.

How to press the Enable switch

Grip the enable switch by the finger on the hand holding the handler.

Example : When gripping by the left hand

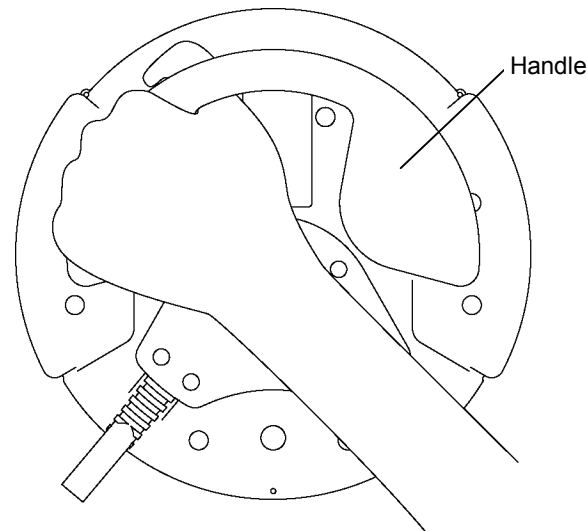

Operation

This section contains information about operation of the Teach Pendant and maintenance procedure.

1. Teaching Procedure

The basic jog operation and teaching procedure is indicated.

Switch the mode selector switch to “Teach” to display the following screen.

```
Jog&Teach Points.pts
Current Position   Arm   :0   Tool  :0
X :    0.000      Y :  490.000
Z :   675.000    U :    0.000
V :   -90.000    W :   -90.000
Point   :0
Label   :
Jog Mode:World 00   Speed   :High
Jog Dist:Medium
X :    1.00      Y :    1.00
Z :    1.00      U :    1.00
V :    1.00      W :    1.00
-----
Edit Pnt  Edit Dist Motion  I/O Cmd
P# +/-:↑↓
```

NOTE



A coordinate point including the arm pose is defined as “position (point),” and the data is called “point data.”

1.1 Jog Operation

Move the Robot to the teaching position by one of the following operation (Step Jog operation, Continuous Jog operation).

Step Jog Operation

In Step Jog, moves the Robot by pressing the Jog key each time.

Jog distance of the Robot is configured before hand.

Press the <Jog Dist> key to specify the [Jog Dist] (Long, Medium, Short).

Execute the step jog by gripping the enable switch as pressing the Jog key.

Continuous Jog Operation

In Continuous Jog, moves the Robot while pressing the Jog key.

Press the <Jog Dist> key to select “Cont Jog” for the [Jog Dist].

Execute the continuous jog by gripping the enable switch as pressing the Jog key.

1.2 Teaching

Apply the Robot position to the specified point number.

- (1) Specify the point number by changing the value in the [Point] using the <↑> and <↓> keys.
[Label] display changes by changing the point number.
- (2) Press the <Teach> key.
- (3) The following screen appears.

```

Teach
Ready to assign current position
to point.
Point      :0

Continue?

-----

Yes:OK No:Cancel
    
```

When the point number is already used, the following screen appears.

```

Teach
Ready to assign current position
to point.
Point      :1

Overwrite?

-----

Yes: OK No: Cancel
    
```

- (4) Press the <OK> key to assign the robot position.
- (5) Press the <Save Points> key to display the following screen.
Enter the file name and press the <Enter> key.

```

Save Points
Point File Name:
Points.pts

-----

Save:OK CancelCancel
    
```

- (6) Press the <OK> key to save the file.

1.3 Direct Teaching

“Direct teach” is a way to teach the Robot directly by setting the teaching joint to servo-OFF.

Apply the Robot position to the specified point number.

- (1) Specify the point number by changing the value in the [Point] using the <↑> and <↓> keys.

[Label] display changes by changing the point number.

- (2) Press the <Jog Dist> key to select “Free Joint” for the [Jog Dist].

Set each joint to servo ON or OFF.

<+> key	: Lock	: Servo OFF the joint
<-> key	: Free	: Servo ON the joint
<F2> key	: All Lock	: Servo OFF all the joint
<F3> key	: All Free	: Servo ON all the joint

- (3) Servo OFF joint can be moved with hands.
Move the Robot arm to the position to teach.
- (4) Press the <Teach> key.

- (5) The following screen appears.

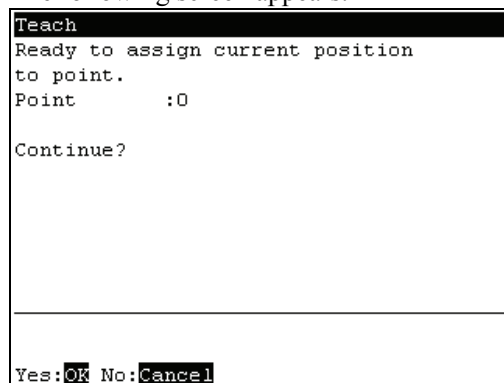

When the point number is already used, the following screen appears.

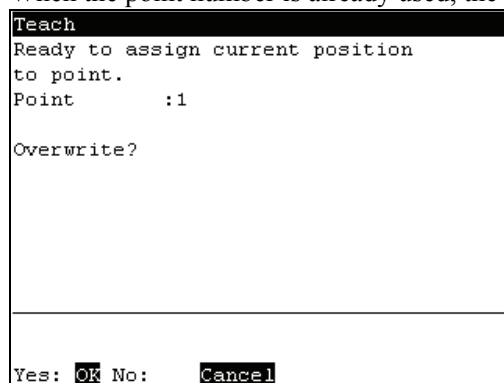

- (6) Press the <OK> key to assign the robot position.

- (7) Press the <Save Points> key to display the following screen.
Enter the file name and press the <Enter> key.

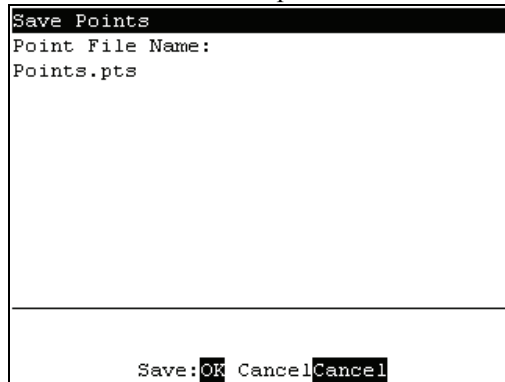

- (8) Press the <OK> key to save the file.

2. TEACH Mode

Switch the mode selector key switch to “Teach” to enter the TEACH mode. In this mode, jog, teaching, operation commands, I/O commands, and other operations and commands can be executed using the Teach Pendant.

Note, however, that the program cluster cannot be executed.

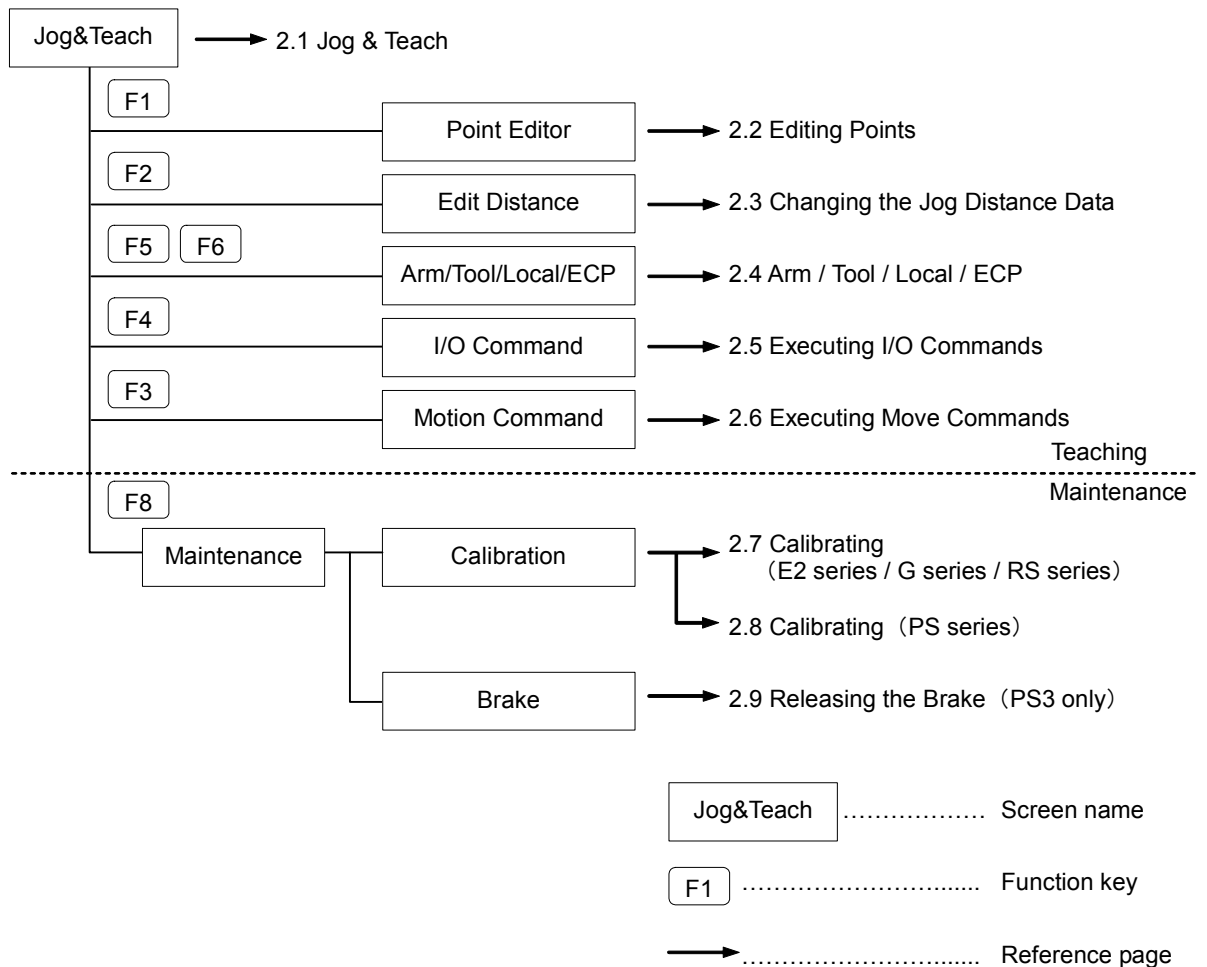

NOTE



A coordinate point including the arm pose is defined as “position (point),” and the data is called “point data.”

2.1 [Jog & Teach]

This section indicates settings in the [Jog&Teach] screen.

- (1) Switch the mode selector key switch to “Teach” to display the following screen.

Jog&Teach Points.pts											
Current Position		Arm	:0 Tool :0								
X :	0.000	Y :	490.000								
Z :	675.000	U :	0.000								
V :	-90.000	W :	-90.000								
Point	:0										
Label	:										
Jog Mode:	World 00	Speed	:High								
Jog Dist:	Medium										
X :	1.00	Y :	1.00								
Z :	1.00	U :	1.00								
V :	1.00	W :	1.00								
<table border="1"> <tr> <td>Edit Pnt</td> <td>Edit Dist</td> <td>Motion</td> <td>I/O Cmd</td> </tr> <tr> <td>P# +/-:↑↓</td> <td></td> <td></td> <td></td> </tr> </table>				Edit Pnt	Edit Dist	Motion	I/O Cmd	P# +/-:↑↓			
Edit Pnt	Edit Dist	Motion	I/O Cmd								
P# +/-:↑↓											

- (2) Set the data items currently displayed in the [Jog&Teach] screen.
(See 2.1.1 to 2.1.6.)
- (3) Note down the robot position. (See 2.1.9.)
- (4) Back up the point data to a file. (See 2.1.10.)

2.1.1 Specifying Point No.

Change the value at [Point] using the <↑> and <↓> keys to specify a point No.
Changing the point No. changes the indication at [Label].

2.1.2 Specifying Jog Mode

Press the <Jog Mode> key and specify the [Jog Mode]. (World, Tool, Joint, ECP)
The default setting is “World”.

World : Jogs the robot along the X, Y, Z axes in the current local, tool, arm, and ECP.
For robots with 4 DOF, you can also jog U (roll).

For robots with 6 DOF, you can jog U (roll), V (pitch), and W (yaw). This is the default setting.

Tool : Jogs the robot in the coordinate system defined by the current tool.

Joint : Jogs each joint of the robot.

A separate set of jog buttons will appear when using joint mode when using non-Cartesian robots.

ECP : Jogs the robot along the axes of the coordinate system defined by the current external control point. Coordinates are World coordinates.

2.1.3 Specifying Jog Speed

Press the <Speed> key and select the speed at [Speed]. (Low, High)

Low : Low jog speed

High : High jog speed

2.1.4 Executing Step Jog

By step jog operation, the robot moves when the Jog key is pressed.

Set the distance that the robot moves beforehand.

(1) Press the <Jog Dist> key and select the distance at [Jog Dist].

Long : Long jog distance

Medium : Medium jog distance

Short : Short jog distance

(2) To execute step jog, grip the Jog key with the enable switch held down.

2.1.5 Executing Continuous Jog

With continuous jog, the robot moves continuously while the Jog key is held down.

(1) Press the <Jog Dist> key and select “Cont Jog” at [Jog Dist].

(2) To execute continuous jog, grip the enable switch while pressing the Jog key.

2.1.6 ON/OFF

Specify On/Off for each joint.

When performing direct teaching (manually moving the robot by hand to perform teaching), set the joint to Off.

Press the <Jog Dist> key and select “Free Joint” at [Jog Dist].

Set On/Off for each joint.

<+> key : Lock : Sets the joint to Off.

<-> key : Free : Sets the joint to On.

<F2> key : All Lock : Sets all joints to Off.

<F3> key : All Free : Sets all joints to On.

2.1.7 Motor ON/OFF

Press the <Motor> key to switch the motor ON and OFF.



This can be executed at any time in TEACH mode.

For RC180-UL:

This can be executed when the enable switch is on.

2.1.8 Executing Return to Home

Press the <Home> key to return the robot to its home position.



This can be executed at any time in TEACH mode.

2.1.9 Teaching

The robot position is assigned to the specified point No.

- (1) Press the <Teach> key.
- (2) The following screen appears.

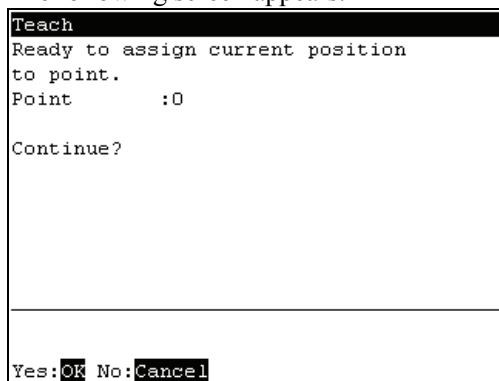

When the point number is already used, the following screen appears.

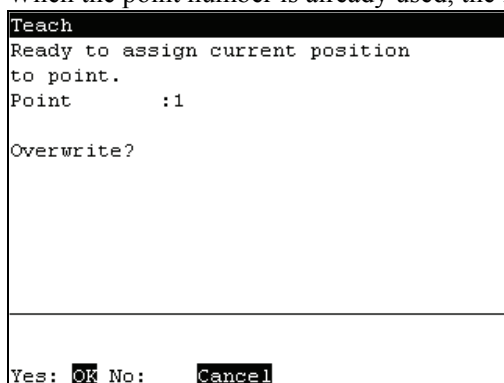

- (3) Press the <OK> key to assign the point data.
- (4) Press the <Save Points> key.



This can also be executed in the [Point Editor] screen.

2.1.10 Saving Point Data to File

- (1) Press the <Save Points> key.
- (2) The following screen appears. Enter the file name, and press the <Enter> key.

```

Save Points
Point File Name:
Points.pts

```

Save: **OK** Cancel **Cancel**

- (3) Press the <OK> key to save the positions to the file.



TIP

This can also be executed in the [Point Editor] screen.

2.1.11 Loading Point Data from File

- (1) Press the <LoadPoints> key.
- (2) The following screen appears. Move the cursor to select a file.

```

Load Points
Point File:
Points.PTS

```

Select: **↑↓** Load: **OK** Cancel **Cancel**

- (3) Press the <OK> key to load the point data in the file memory.



TIP

This can also be executed in the [Point Editor] screen.

2.2 Editing Points

This section indicates settings in the [Point Editor] screen.

- (1) Press the <F1> key in the [Jog&Teach] screen. The following screen appears.

```

Point Editor
Point :0      Label :PickUp

Position
X :300.000   Y :300.000
Z :300.000   U :90.000
V :0.000     W :-180.000

Hand :Righty   Elbow:Above
Wrist:No Flip  J4F :0
Local:00      J6F :000

Point#       Delete  J&T
Select:↑↓   Set: Enter OK:OK
    
```

- (2) Set the data items currently displayed in the [Point Editor] screen. (See 2.2.1 to 2.2.4.)
- (3) Note down the robot position. (See 2.1.9.)
- (4) Back up the point data to a file. (See 2.1.10.)

2.2.1 Specifying Point No.

- (1) Specify the point number by changing the value in the [Point] using the <↑> and <↓> keys.
Change the point No. to change the indication at [Label].
- (2) Press the <Enter> key.
- (3) Press the <OK> key to apply the memory.

2.2.2 Changing Point Label

- (1) Press the <F1> key and move the cursor to [Label].
- (2) Enter the label name at [Label] to set the name.
- (3) Press the <Enter> key.
- (4) Press the <OK> key to apply the memory.

2.2.3 Changing Coordinate Data and Pose Flag

- (1) Press the <F2> key and move the cursor to [Position: X].
- (2) Move the cursor to each joint, and set the coordinate data/pose flag.
- (3) Press the <Enter> key.
- (4) Press the <OK> key to apply the memory.

2.2.4 Deleting Point Data

Press the <F3> key to delete the point data.

2.3 Changing Jog Distance Data

This section indicates settings in the [Jog Distance] screen.

Press the <F2> key in the [Jog&Teach] screen.

The following screen appears.

Jog Distance		
Distance: Medium		
X	1.00	[mm]
Y	1.00	[mm]
Z	1.00	[mm]
U	1.00	[deg]
V	1.00	[deg]
W	1.00	[deg]
Default		
Select:	↑↓	Set: Enter OK: OK Cancel: Cancel

When a value has been changed, press the <Enter> key to apply the value, and be sure to press the <OK> key to save the settings.

2.3.1 Changing Distance Data

Set the distance for each joint.

- (1) Move the cursor to [Distance], press the <Jog Dist> key to select the distance (Long, Medium, Short) that is to be changed.
- (2) Move the cursor to each joint, and set the value.

2.3.2 Return Data to Defaults

Press the <F1> key to return jog distance data to their defaults.

2.4 Arm/Tool/Local/ECP

This section indicates settings in the [Arm/Tool/Local/ECP] screen.

Press the <F5> or <F6> key in the [Jog&Teach] screen.

The following screen appears.

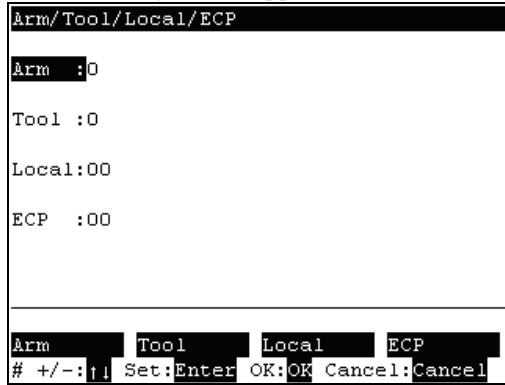

When a value has been changed, press the <Enter> key to apply the value, and be sure to press the <OK> key to save the settings.

2.4.1 Changing Arm No.

- (1) Press the <F1> key and move the cursor to [Arm].
- (2) Set the arm number.

2.4.2 Changing Tool No.

- (1) Press the <F2> key and move the cursor to [Tool].
- (2) Set the tool number.

2.4.3 Changing Local No.

- (1) Press the <F3> key and move the cursor to [Local].
- (2) Set the local number.

2.4.4 Changing ECP No.

- (1) Press the <F4> key and move the cursor to [ECP].
- (2) Set the ECP No.

2.5 Executing I/O Commands

This section indicates settings in the [I/O Command] screen.

Press the <F4> key in the [Jog&Teach] screen.

The following screen appears.

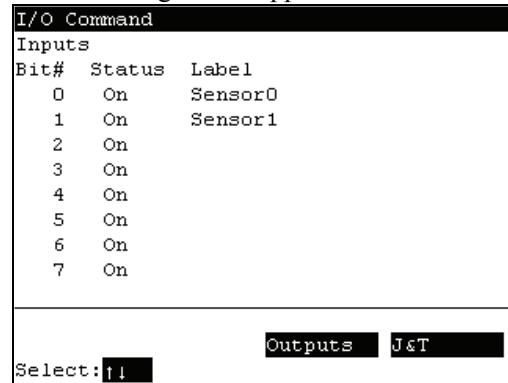

2.5.1 Switching Input/Output Status Display

Press the <F3> key to switch between the “Inputs” status and the “Outputs” status display.

2.5.2 Output Bit ON/OFF

- (1) Press the <F3> key to display the “Outputs” status.

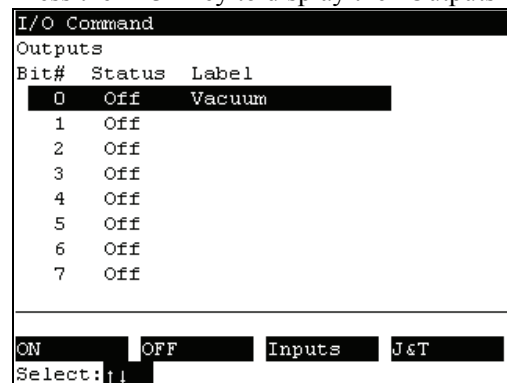

- (2) Move the cursor to the output bit that you want to change.
- (3) Switch the ON/OFF status of the output bit.
 - <F1> key: On
 - <F2> key: Off

2.6 Executing Motion Commands

2.6.1 E2 Series / G Series / RS Series

This item indicates the procedure for executing motion commands when using E2 series / G series / RS Series robots.

- (1) Press the <F3> key in the [Jog&Teach] screen.

The following screen appears.

Move the cursor to the desired motion command, and press the <OK> key.

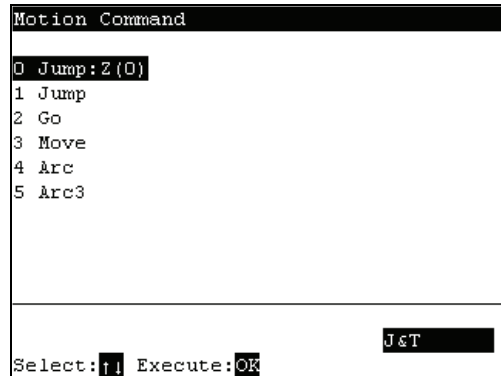

- (2) The motion command screen appears.
Set the information required for the command, and press the <Enter> key to apply the settings.
- (3) Press the <OK> key to execute the command.

2.6.2 PS Series

This item indicates the procedure for executing motion commands when using PS series robots.

- (1) Press the <F3> key in the [Jog&Teach] screen. The following screen appears.

Move the cursor to the desired motion command, and press the <OK> key.

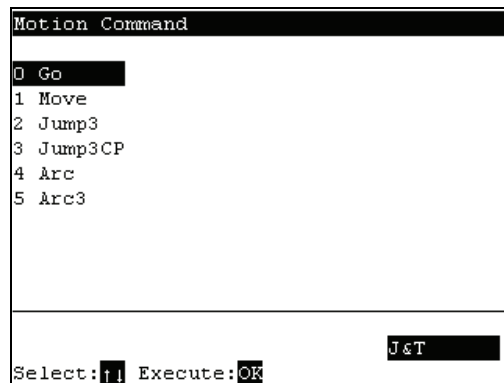

- (2) The motion command screen appears.
Set the information required for the command, and press the <Enter> key to apply the settings.
- (3) Press the <OK> key to execute the command.

2.7 Calibrating Origin : E2 Series / G Series / RS Series

This item indicates the procedure to calibrate the origin when using E2 series / G series / RS series robots.

Follow the procedure below to display the [Calibration] screen.

- (1) Press the <F8> key in the [Jog&Teach] screen
- (2) The following screen appears.

Move the cursor to “0 calibration” and press the <OK> key.



NOTE

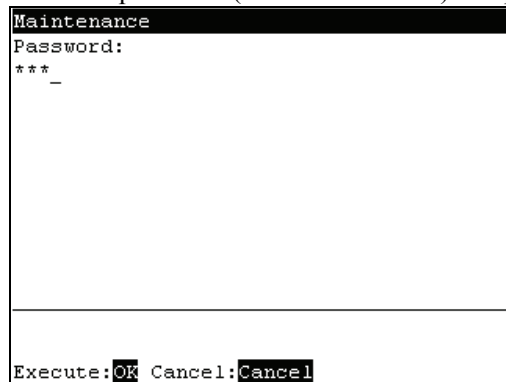

The following screen appears when the password is set up.

Enter the password (1 to 16 characters) and press the <OK> key.

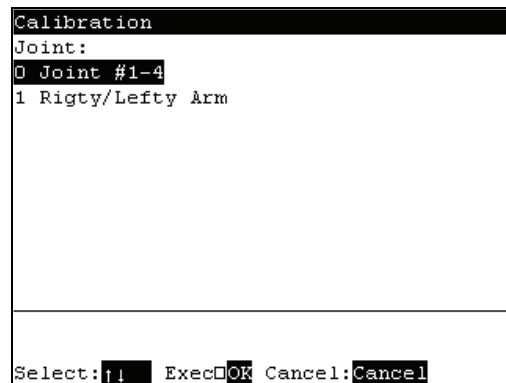

For password setting, refer to *Operation 4. Password Setup*.

- (3) The following calibration menu screen appears.



2.7.1 Calibration Procedures (E2 Series)

 CAUTION	<ul style="list-style-type: none"> Calibrate Joint #3 first when aligning origins of more than one joint. When Joint #3 is too low, it may collide with peripheral equipment during the calibration of the other joints and may damage the peripheral equipment.
---	---

The same calibration procedure is used for all joints. Follow the steps below to calibrate each joint.

When calibrating Joint #4, you must calibrate Joint #3 and #4 at the same time. You cannot calibrate Joint #4 alone because of the structure of the Manipulator.

- In the [Calibration] screen, move the cursor to “0 Joint #1-4”, and press the <OK> key.

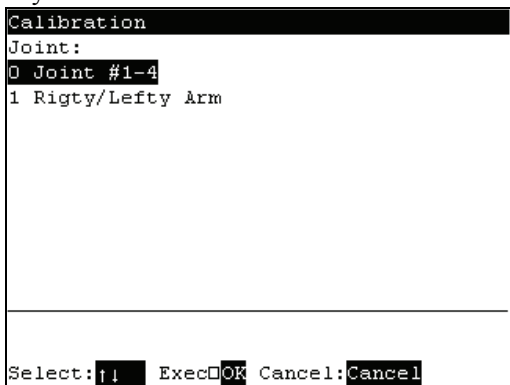

- The following screen appears. Press the <F2> key.

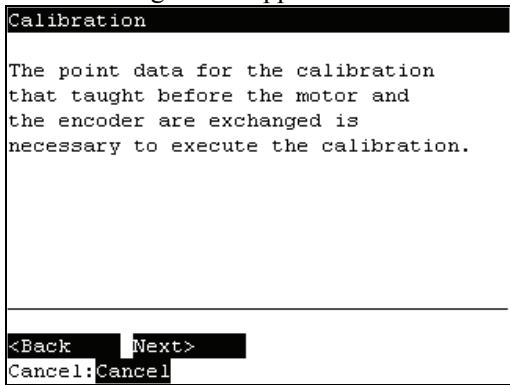

- The following screen appears.

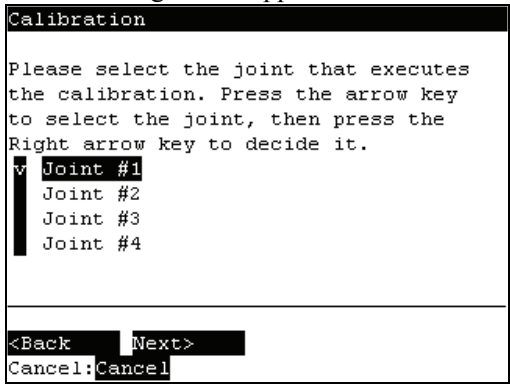

Move the cursor to the joint to calibrate. Press the <→> key to select the joint and press the <F2> key.

<→> key : Joint selection

<←> key : Joint selection reset

The following screen appears when selection Joint #4 and Joint #3 is selected automatically.

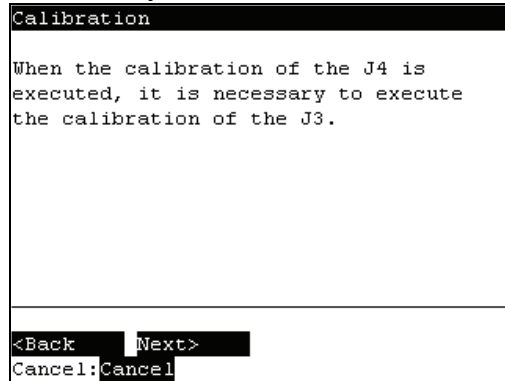

- (4) When a message appears regarding the capacitor charge, leave the power ON for 3 or more minutes to sufficiently charge the capacitor. Press the <F2> key to display the following screen.

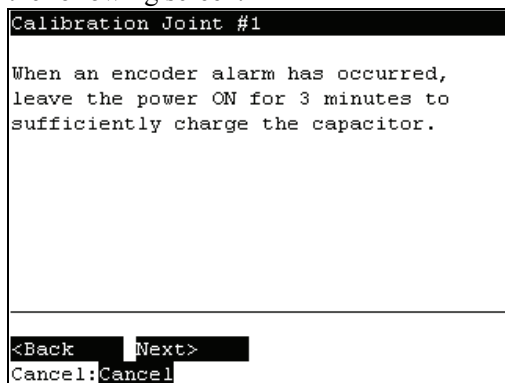

- (5) The following screen appears.

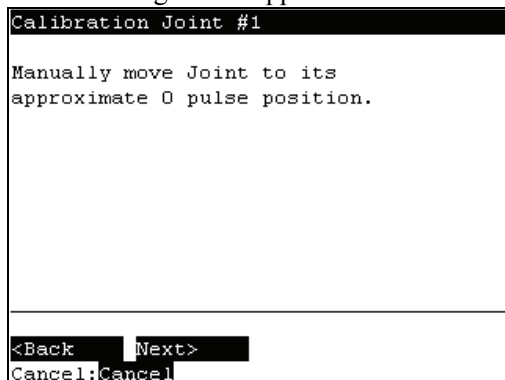

- (6) Manually move the joint that needs origin alignment to its approximate 0 pulse position.

0 pulse position of Joint #1 : position aligned with X-axis in Manipulator coordinate system

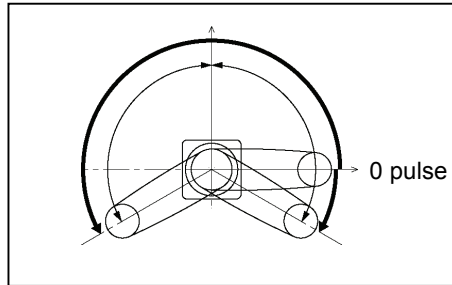

0 pulse position of Joint #2 : position where Arms #1 and #2 are in a straight line (Regardless of the Joint #1 direction)

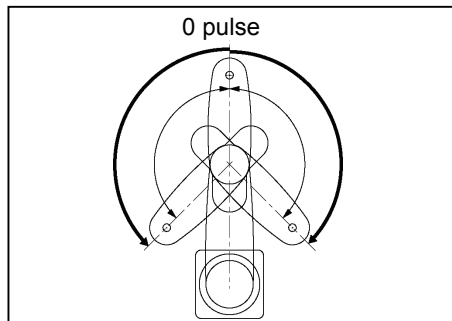

0 pulse position of Joint #3 : upper limit position in motion range

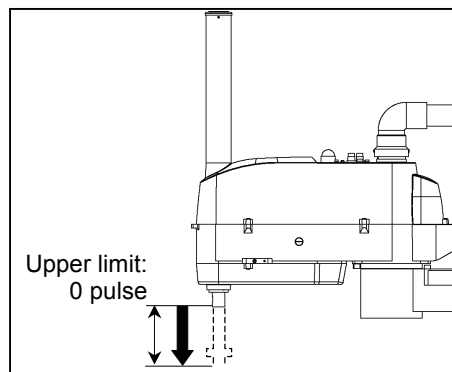

0 pulse position of Joint #4 : position where the flat surface on the shaft faces toward the tip of Arm #2

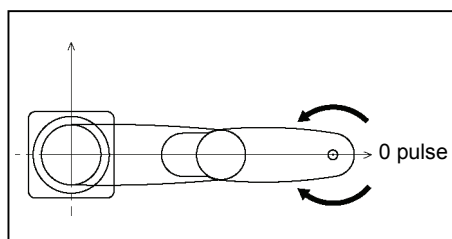

- (7) Press the <F2> key. The following screen appears.

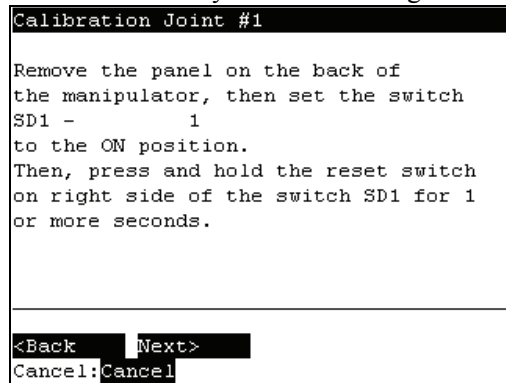

- (8) Remove the acrylic panel on the sensor monitor on the base connector plate.

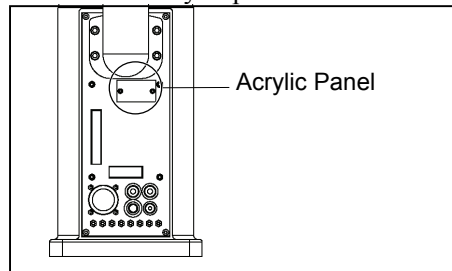

- (9) Set one of the DIP switches (SD1) "1" to "4" corresponding to the calibrating Joint to its ON position.

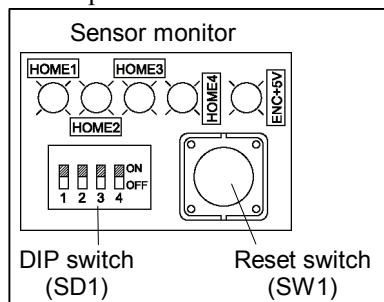

- (10) Press and hold the reset switch (SW1) for 1 or more seconds.

- (11) Press the <F2> key to display the following screen.

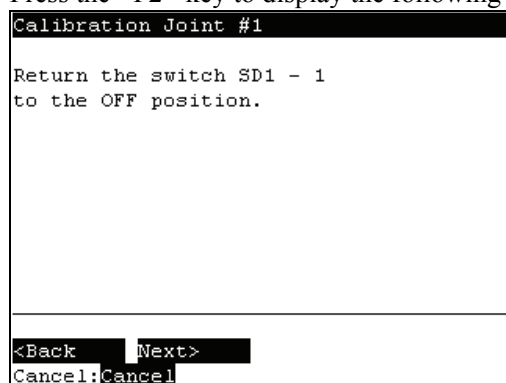

- (12) Turn OFF the DIP switch and mount the acrylic panel on the sensor monitor.

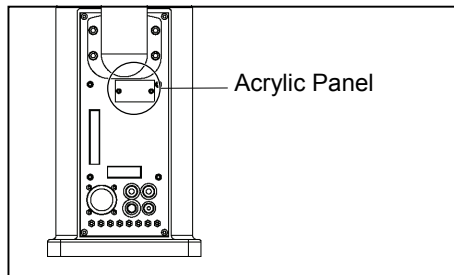

- (13) Press the <F2> key. The following screen appears. Press the <F2> key again.

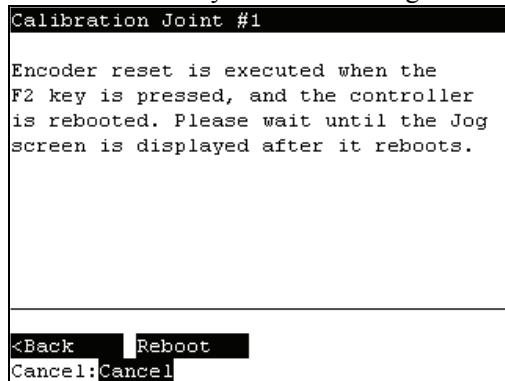

- (14) Controller reboots and the following screen appears.

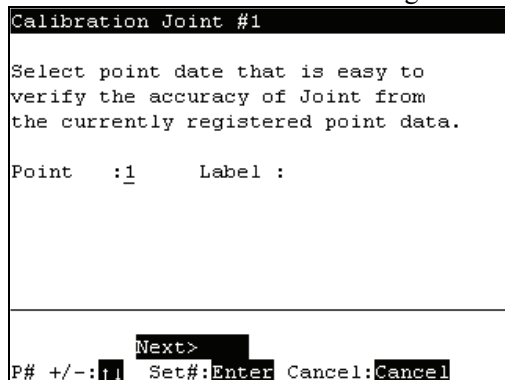

Select one of the currently registered point data that is easy to verify the accuracy of the calibrating joint using the <↑> and <↓> keys, and press the <Enter> key. Press the <F2> key.

NOTE The Manipulator does not move to the exact point because the specified origin is determined visually. Although the error is less than one revolution of the motor, be careful not to allow the Manipulator to interfere with peripheral equipment.

Difference

	E2C	E2S	E2L	E2H
Joint #1	±4.5 degrees	±4.5 degrees	±3.6 degrees	±3.6 degrees
Joint #2	±7.2 degrees	±7.2 degrees	±4.5 degrees	±4.5 degrees
Joint #3	±13.3 mm	±13.3 mm	±13.3 mm	±13.9 mm
Joint #4	±31.65 degrees	±22.5 degrees	±22.5 degrees	±17.1 degrees

(15) The following screen appears.

Press the <Motor> key to turn ON the motor. Press the <F2> key.

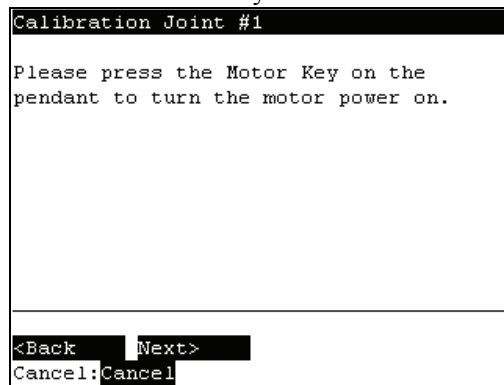

(16) The following screen appears. Press the <OK> key to stop the servo control for all joints to enable the joints to be moved manually.

Press the <F2> key to display the following screen.

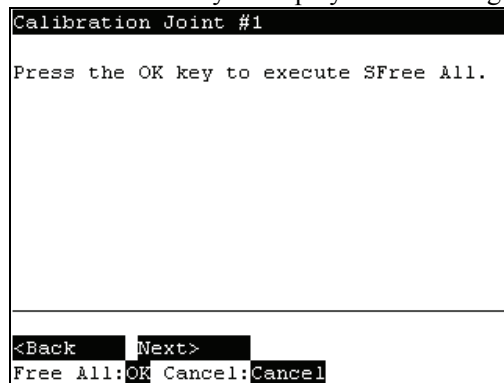

(17) The following screen appears. Manually move and position the joint that needs origin alignment while pushing the Joint #3 brake release button and lowering Joint #3. Press the <F2> key.

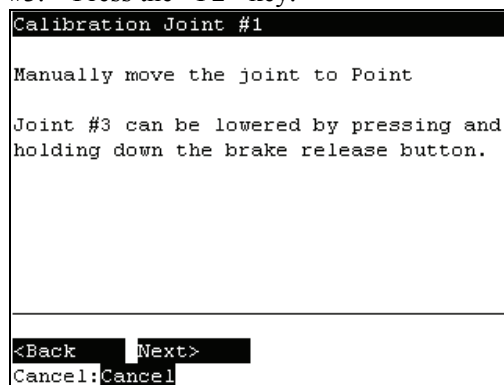

- (18) The following screen appears. Press the <F1> key to execute temporary calibration.

```

Calibration Joint #1

Point P1
The temporary calibration is executed.

Yes No
Cancel:Cancel
    
```

The following screen appears after executing the temporary calibration.

Press the <OK> key to servo control all joints.

Press the <F2> key.

```

Calibration Joint #1

Press the OK key to execute SLock All.

<Back Next>
Lock All:OK Cancel:Cancel
    
```

- (19) The following screen appears.

```

Calibration Joint #1

To set other joints to the position and
the pose of the point accurately,
GO P1 is executed.
Hold the Enabel switch and press the OK
key and hold down until the Jog screen
is displayed.

<Back
Cancel:Cancel
    
```

Move the joints except the calibrated joints to the point data position by the motion command. For an example the motion command will be executed to Joint #1 and #2 when Joint #4 is calibrated.

Press the <OK> key while gripping the enable switch to execute Go P1.

The following screen appears during Go P1 execution.

```

Calibration Joint #1

Executing...

When Enable Switch or OK key is
released, the manipulator stops.

Stop:Release OK or Enable SW
    
```

(20) The following screen appears after Go P1 execution.

```

Calibration Joint #1

Press the Jog keys to move the
Joint 1
to the point accurately.

Speed   :Low
Mode    :Joint
Jog Dist:Long
J1:     10.000    J2:     10.000
J3:     10.000    J4:     10.000

<Back   Next>
Cancel:Cancel
    
```

Set the calibrated joints to the selected point data position accurately by the jog motion.

Press the Jog key to move the joint to the basic pose as accurate as possible.

Press the <F2> key.

(21) The following screen appears. Press the <F1> key.

```

Calibration Joint #1

The calibration is executed.
Calibrate?

Yes   No
Cancel:Cancel
    
```

(22) The origin calibration completed screen appears.

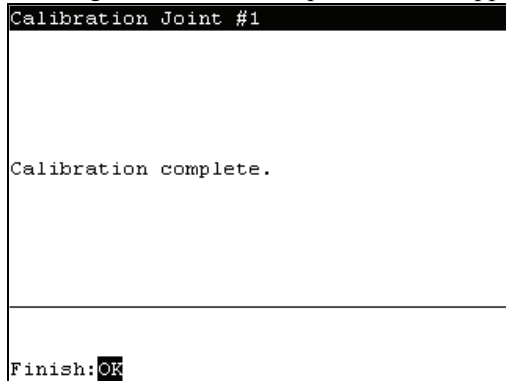

NOTE

For righty or lefty setting, refer to 2.7.3 *Setting Righty / Lefty*.

2.7.2 Calibration Procedures (G Series / RS Series)

 CAUTION	<ul style="list-style-type: none"> Calibrate Joint #3 first when aligning origins of more than one joint. When Joint #3 is too low, it may collide with peripheral equipment during the calibration of the other joints and may damage the peripheral equipment.
---	---

The same calibration procedure is used for all joints. Follow the steps below to calibrate each joint.

When calibrating Joint #4, you must calibrate Joint #3 and #4 at the same time. You cannot calibrate Joint #4 alone because of the structure of the Manipulator.

(1) In the [Calibration] screen, move the cursor to "0 Joint #1-4", and press the <OK> key.

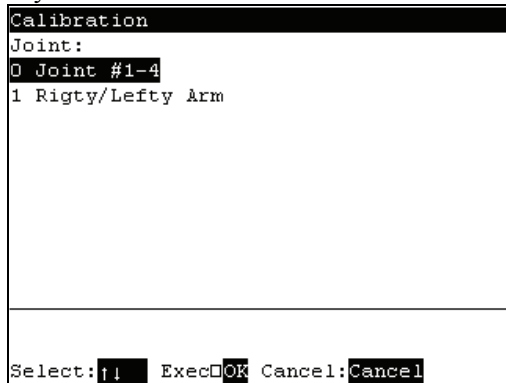

(2) The following screen appears. Press the <F2> key.

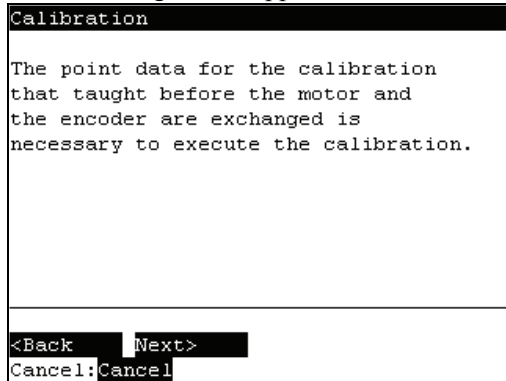

(3) The following screen appears.

```

Calibration
Please select the joint that executes
the calibration. Press the arrow key
to select the joint, then press the
Right arrow key to decide it.
v Joint #1
  Joint #2
  Joint #3
  Joint #4

<Back      Next>
Cancel:Cancel
    
```

Move the cursor to the joint to calibrate. Press the <-> key to select the joint and press the <F2> key.

<-> key : Joint selection

<<-> key : Joint selection reset

The following screen appears when selection Joint #4 and Joint #3 is selected automatically.

```

Calibration
When the calibration of the J4 is
executed, it is necessary to execute
the calibration of the J3.

<Back      Next>
Cancel:Cancel
    
```

(4) The following screen appears.

```

Calibration Joint #1
Manually move Joint to its
approximate 0 pulse position.

<Back      Next>
Cancel:Cancel
    
```

- (5) Manually move the joint that needs origin alignment to its approximate 0 pulse position.

G series 0 pulse position of Joint #1 : position aligned with X-axis in Manipulator coordinate system

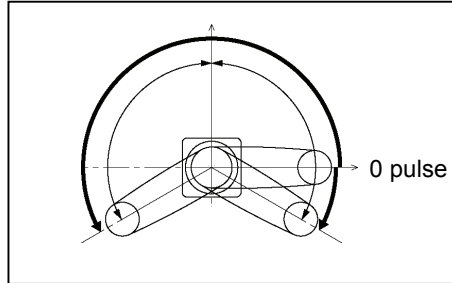

0 pulse position of Joint #2 : position where Arms #1 and #2 are in a straight line (Regardless of the Joint #1 direction)

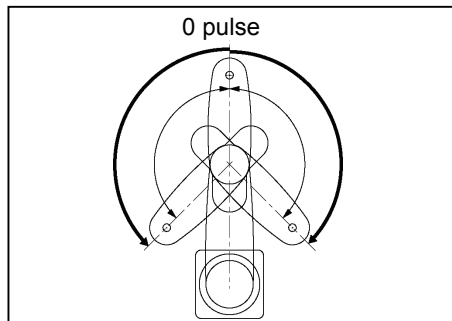

0 pulse position of Joint #3 : upper limit position in motion range

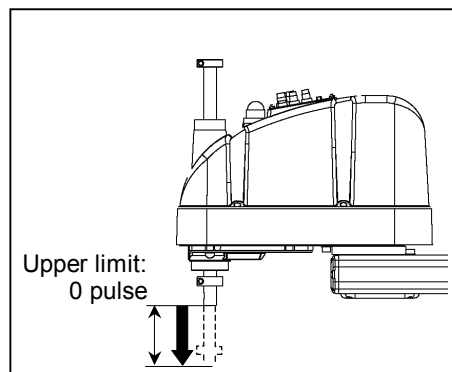

0 pulse position of Joint #4 : position where the flat surface on the shaft faces toward the tip of Arm #2

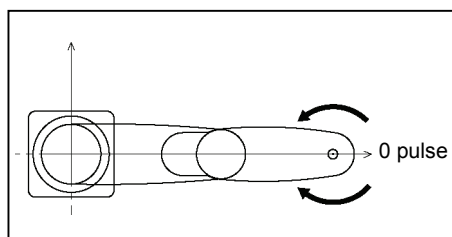

RS series 0 pulse position of Joint #1 : position aligned with X-axis in Manipulator coordinate system

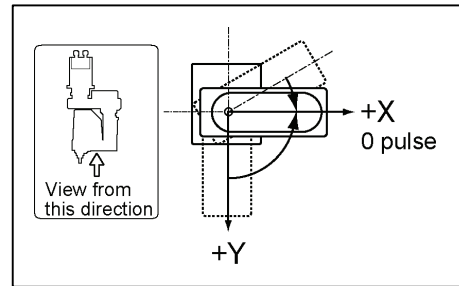

0 pulse position of Joint #2 : position where Arms #1 and #2 are in a straight line (Regardless of the Joint #1 direction)

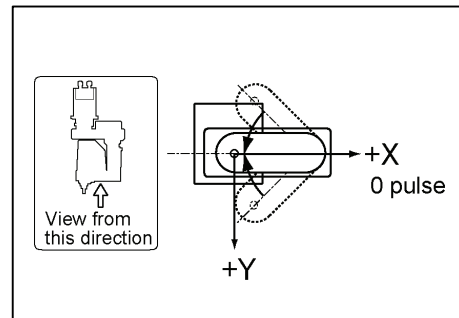

0 pulse position of Joint #3 : upper limit position in motion range

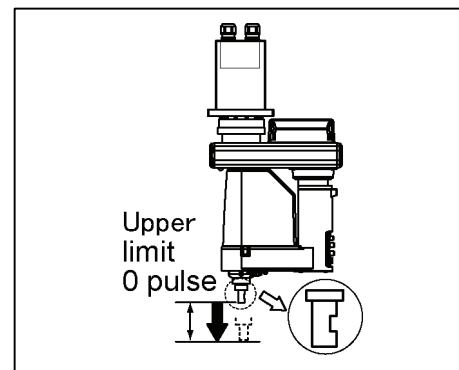

0 pulse position of Joint #4 : position where the flat surface on the shaft faces toward the tip of Arm #2

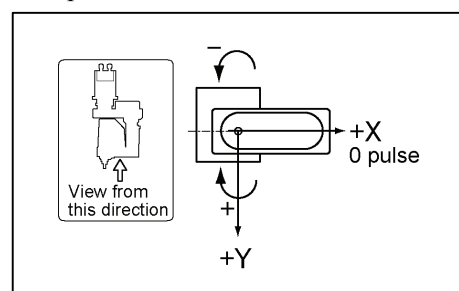

- (6) Press the <F2> key. The following screen appears. Press the <F2> key again.

```

Calibration Joint #1

Encoder reset is executed when the
F2 key is pressed, and the controller
is rebooted.
Please wait until the selecting point
screen is displayed after it reboots.

<Back      Reboot
Cancel:Cancel
    
```

- (7) Controller reboots and the following screen appears.

```

Calibration Joint #1

Select point data that is easy to
verify the accuracy of Joint from
the currently registered point data.

Point  :_1      Label :

Next>
P# +/-: | Set#:Enter Cancel:Cancel
    
```

Select one of the currently registered point data that is easy to verify the accuracy of the calibrating joint using the <↑> and <↓> keys, and press the <Enter> key. Press the <F2> key.



The Manipulator does not move to the exact point because the specified origin is determined visually. Although the error is less than one revolution of the motor, be careful not to allow the Manipulator to interfere with peripheral equipment.

Difference

	G3	G6	G10	G20	RS series
Joint #1	±4.5 °	±4.5 °	±4.5 °		±7.2°
Joint #2	±7.2 °	±7.2 °	±7.2 °		±7.1°
Joint #3	±13.3 mm	Z 180 : ±11.94 mm	Z 180 : ±12.12 mm		Z130 : ±13.33 mm
		Z 330 : ±23.87 mm	Z 420 : ±24.24 mm		
Joint #4	±4.5 °	±24.06 °	±24.18°	±17.14°	±30°

(° : degrees)

- (8) The following screen appears.

Press the <Motor> key to turn ON the motor. Press the <F2> key.

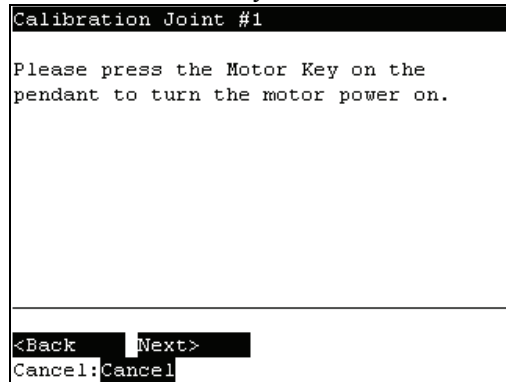

- (9) The following screen appears. Press the <OK> key to stop the servo control for all joints to enable the joints to be moved manually.

Press the <F2> key to display the following screen.

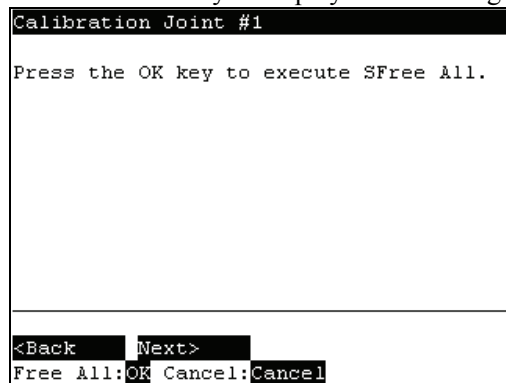

- (10) The following screen appears. Manually move and position the joint that needs origin alignment while pushing the Joint #3 brake release button and lowering Joint #3. Press the <F2> key.

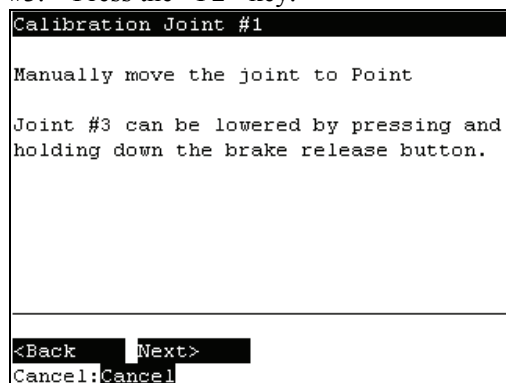

- (11) The following screen appears. Press the <F1> key to execute temporary calibration.

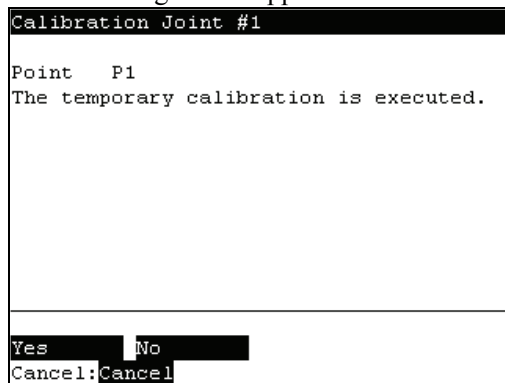

The following screen appears after executing the temporary calibration.

Press the <OK> key to servo control all joints.

Press the <F2> key.

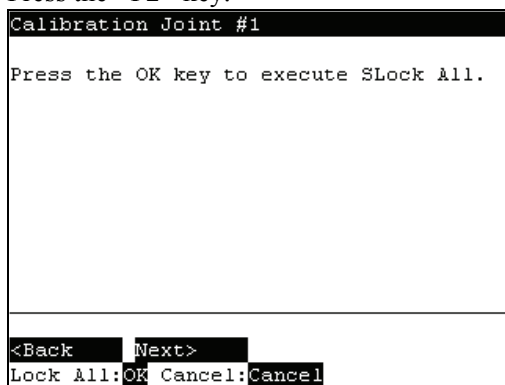

- (12) The following screen appears.

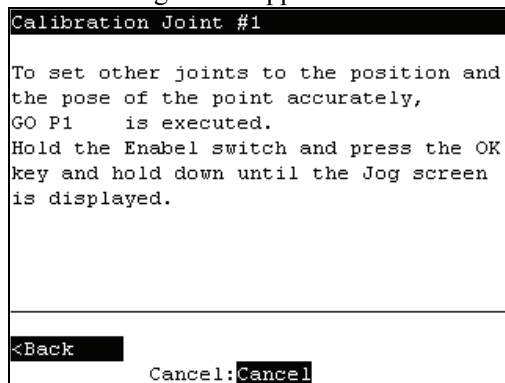

Move the joints except the calibrated joints to the point data position by the motion command. For an example the motion command will be executed to Joint #1 and #2 when Joint #4 is calibrated.

Press the <OK> key while gripping the enable switch to execute Go P1.

The following screen appears during Go P1 execution.

```

Calibration Joint #1

Executing...

When Enable Switch or OK key is
released, the manipulator stops.

Stop:Release OK or Enable SW
    
```

(13) The following screen appears after Go P1 execution.

```

Calibration Joint #1

Press the Jog keys to move the
Joint 1
to the point accurately.

Speed   :Low
Mode    :Joint
Jog Dist:Long
J1:     10.000    J2:     10.000
J3:     10.000    J4:     10.000

<Back   Next>
Cancel:Cancel
    
```

Set the calibrated joints to the selected point data position accurately by the jog motion.

Press the Jog key to move the joint to the basic pose as accurate as possible.

Press the <F2> key.

(14) The following screen appears. Press the <F1> key.

```

Calibration Joint #1

The calibration is executed.
Calibrate?

Yes   No
Cancel:Cancel
    
```

(15) The origin calibration completed screen appears.

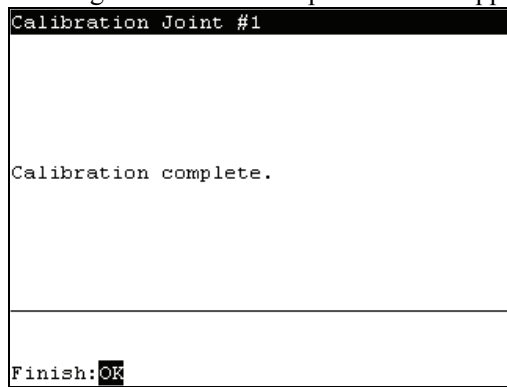

NOTE



For righty or lefty setting, refer to 2.7.3 *Setting Righty / Lefty*.

2.7.3 Setting Righty / Lefty (E2 Series / G Series / RS Series)

- (1) In the [Calibration] screen, move the cursor to “Righty/Lefty”, and press the <OK> key.

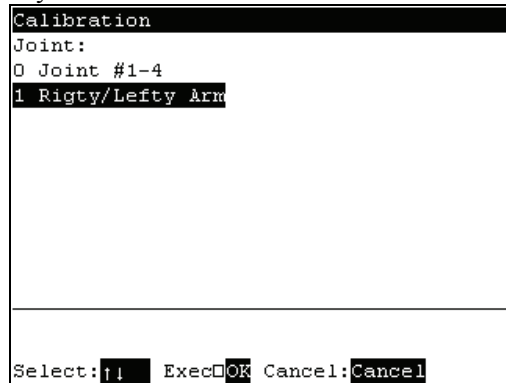

- (2) The following screen appears. Select one of the point data in the accessible area that is easy to verify the accuracy for both right and left arm orientations using the <↑> and <↓> keys and press the <Enter> key.

Press the <F2>key.

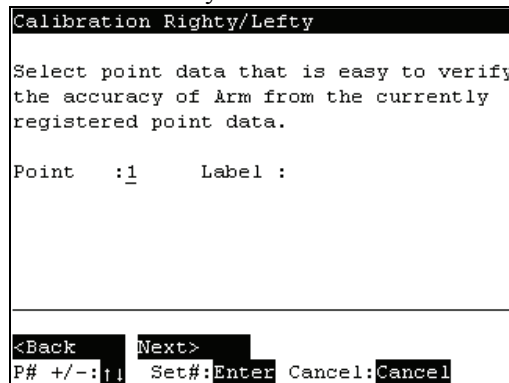

- (3) The following screen appears. Press the <Motor> key to turn ON the motor.

Press the <F2> key.

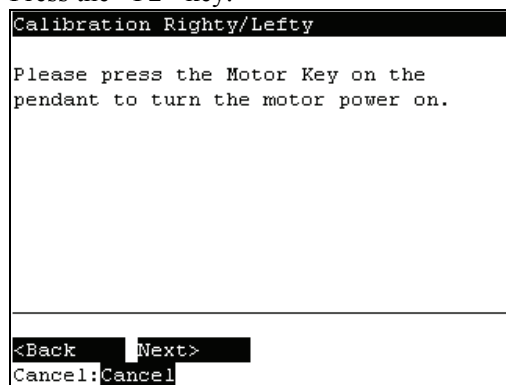

- (4) Continue to press the <OK> key with the enable switch held down to execute Jump P1.

```

Calibration Righty/Lefty

Jump P1   is executed.

Hold the Enable switch.
Then, press the OK key and hold down.

<Back
Cancel:Cancel
    
```

The following screen appears during Jump P1 execution.

```

Calibration Righty/Lefty

Executing...

When Enable Switch or OK key is
released, the manipulator stops.

Stop:Release OK or Enable SW
    
```

- (5) The following screen appears after Jump P1 execution. Press the <F2> key.

```

Calibration Righty/Lefty

The arm orientation is switched between
right and left.

<Back Next>
Cancel:Cancel
    
```

- (6) The following screen appears.

```

Calibration Righty/Lefty

Jump P1  /R is executed.

Hold the Enable switch.
Then, press the OK key and hold down.

<Back
Cancel:Cancel
    
```

Switch the arm orientation between right and left and move to the same point.
Press the <OK> key while gripping the enable switch to execute Jump P1.

The following screen appears during Jump P1.

```

Calibration Righty/Lefty

Executing...

When Enable Switch or OK key is
released, the manipulator stops.

Stop:Release OK or Enable SW
    
```

- (7) The following screen appears after executing Jump P1.
 Set the calibrated joints to the basic pose accurately by the jog key.
 Press the <F2> key.

```

Calibration Righty/Lefty

Press the Jog keys to move each joint
to the point accurately.

Speed   :Low
Mode    :World
Jog Dist:Long
X :      10.000      Y :      10.000
Z :      10.000      U :      10.000

<Back   Next>
Cancel:Cancel
    
```

- (8) The following screen appears.
 Press the <F1> key.

```

Calibration Righty/Lefty

The calibration is executed.
Calibrate?

Yes     No
Cancel:Cancel
    
```

- (9) The origin calibration completed screen appears.

```

Calibration Righty/Lefty

Calibration complete.

Finish: OK
    
```

2.8 Calibrating Origin : PS Series

This section indicates the procedure to calibrate the origin when using PS series robots.

The same calibration procedure is used for all joints. Follow the steps below to calibrate each joint.

When calibrating Joint #5, you must calibrate Joint #5 and #6 at the same time. You cannot calibrate Joint #5 alone because of the structure of the Manipulator.

(1) Press the <F8> key in the [Jog&Teach] screen.

(2) The following screen appears.

Move the cursor to "0 calibration" and press the <OK> key.



NOTE



The following screen appears when the password is set up.

Enter the password (1 to 16 characters) and press the <OK> key.

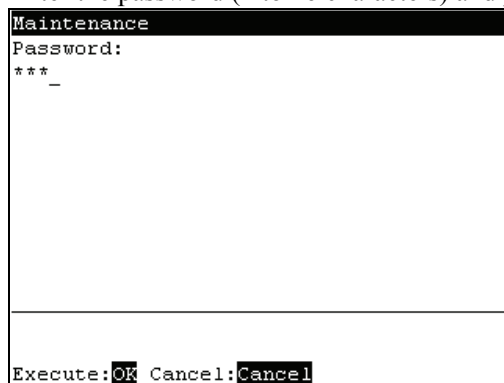

For password setting, refer to *Operation 4. Password Setup*.

(3) The following screen appears. Press the <F2> key.

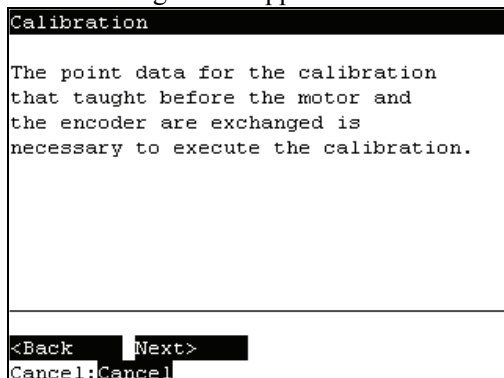

- (4) The following screen appears.

```

Calibration
Please select the joint that executes
the calibration. Press the arrow key
to select the joint, then press the
Right arrow key to decide it.
Joint #1
Joint #2
Joint #3
Joint #4
Joint #5
Joint #6
<Back      Next>
Cancel:Cancel
    
```

Move the cursor to the joint to calibrate. Press the <-> key to select the joint and press the <F2> key.

<-> key : Joint selection

<<-> key : Joint selection reset

The following screen appears when selecting Joint #5 and Joint #6 is selected automatically.

```

Calibration
When the calibration of the J5 is
executed, it is necessary to execute
the calibration of the J6.
<Back      Next>
Cancel:Cancel
    
```

- (5) The following screen appears. Press the <F2> key.

```

Calibration Joint #1
Encoder reset is executed when the
F2 key is pressed, and the controller
is rebooted.
Please wait until the motor screen is
displayed after it reboots.
<Back      Reboot
Cancel:Cancel
    
```

- (6) The Controller reboots and the following screen appears.

Press the <Motor> key to turn ON the motor. Press the <F2> key.

```

Calibration Joint #1

Please press the Motor Key on the
pendant to turn the motor power on.

Next>
Cancel:Cancel
    
```

- (7) The following screen appears.

Press the Jog key and move the joint close to 0 pulse.

When the joint does not move to 0 pulse, move the joint to the set basic pose marked in *Setup & Operation Setting the Basic Pose for Calibration* in the Manipulator manual.

Press the <F2> key.

```

Calibration Joint #1

Press the Jog keys to move the
joint 1
to 0 pulse position.

Speed :Low
Mode :Joint
Jog Dist:Medium
J1: 1.000 J2: 1.000
J3: 1.000 J4: 1.000
J5: 1.000 J6: 1.000

<Back Next>
Cancel:Cancel
    
```

- (8) The following screen appears. Press the <F2> key.

```

Calibration Joint #1

Encoder reset is executed when the
F2 key is pressed, and the controller
is rebooted.
Please wait until the selecting point
screen is displayed after it reboots.

<Back Reboot
Cancel:Cancel
    
```

- (9) Select a point data that is easy to verify the accuracy of the joint that needs origin alignment from the currently registered point data using the <↑> and <↓> keys, and press the <Enter> key.

Press the <F2> key.

```

Calibration Joint #1

Select point data that is easy to
verify the accuracy of Joint from
the currently registered point data.

Point  :0      Label :

Next>
P# +/-: ↑↓ Set#: EnterCancelCancel
    
```

- (10) The following screen appears.

Press the <Motor> key to turn ON the motor.

Press the <F2> key.

```

Calibration Joint #1

Please press the Motor Key on the
pendant to turn the motor power on.

<Back  Next>
Cancel:Cancel
    
```

- (11) The following screen appears.

Press the Jog key to move the joint to the basic pose as accurate as possible.

Press the <F2> key.

```

Calibration Joint #1

Press the Jog keys to move the
manipulator to the point.

Speed  :Low
Mode   :Joint
Jog Dist:Medium
J1:    1.000    J2:    1.000
J3:    1.000    J4:    1.000
J5:    1.000    J6:    1.000

<Back  Next>
Cancel:Cancel
    
```

- (12) The following screen appears. Press the <F1> key to execute temporary calibration.

```

Calibration Joint #1
Point P0
The temporary calibration is executed.
Calibrate?

Yes No
Cancel:Cancel
    
```

- (13) The following screen appears after executing the temporary calibration.

```

Calibration Joint #1

To set other joints to the position and
the pose of the point accurately,
GO P0 is executed.
Hold the Enable switch and press the OK
key and hold down until the Jog screen
is displayed.

<Back
Execute:OK Cancel:Cancel
    
```

Move the joints except the calibrated joints to the point data position by the motion command. For an example the motion command will be executed to Joint #1 to #4 when Joint #5 is calibrated.

Press the <OK> key while gripping the enable switch to execute Go P0.

The following screen appears during Go P0 execution.

```

Calibration Joint #

Executing...

When Enable Switch or OK key is
released, the manipulator stops.
    
```

- (14) The following screen appears after Go P0 execution.

```

Calibration Joint #1

Press the Jog keys to move the
Joint 1
to the point accurately.

Speed :Low
Mode :Joint
Jog Dist:Medium
J1: 1.000 J2: 1.000
J3: 1.000 J4: 1.000
J5: 1.000 J6: 1.000

<Back Next>
Cancel:Cancel
    
```

Move the calibrated joints to the selected point data position accurately by the jog motion. For an example, Joint #5 and #6 is the calibrated joints.
 Press the Jog key to move the joint to the basic pose as accurate as possible.
 Press the <F2> key.

- (15) The following screen appears. Press the <F1> key.

```

Calibration Joint #1

The calibration is executed.
Calibrate?

Yes No
Cancel:Cancel
    
```

- (16) The origin calibration completed screen appears.

```

Calibration Joint #1

Calibration complete.

Finish:OK
    
```

2.9 Releasing Brake (PS series only)

This section indicates the brake ON / OFF switching for each joint.

(1) Press the <F8> key in the [Jog&Teach] screen.

(2) The following screen appears.

Move the cursor to “1 Brake” and press the <OK> key.



The following screen appears when the password is set up.

Enter the password (1 to 16 characters) and press the <OK> key.



For password setting, refer to *Operation 4. Password Setup*.

(3) The following screen appears.

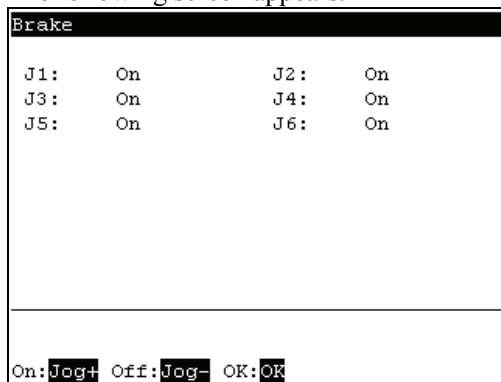

To turn the brake ON

- (4) Press the <Jog+> key of the joint whose brake On/Off setting is to be switched.
- (5) Press the <OK> key. The brake is locked.

To turn the brake OFF

- (4) Press the <Jog-> key of the joint whose brake On/Off setting is to be switched.
- (5) The brake Off confirmation message appears. Confirm the message and press the <F1> key.

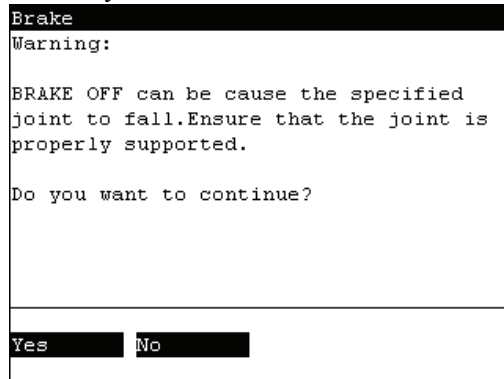

- (6) The brake is released, and the specified joint moves manually.

3. AUTO Mode

Switch the mode selector key switch to “Auto” to enter the AUTO mode. In this mode, jog, teaching, operation commands, I/O commands, and other operations and commands can be executed using the teaching pendant.

Note, however, that the program cluster cannot be executed.

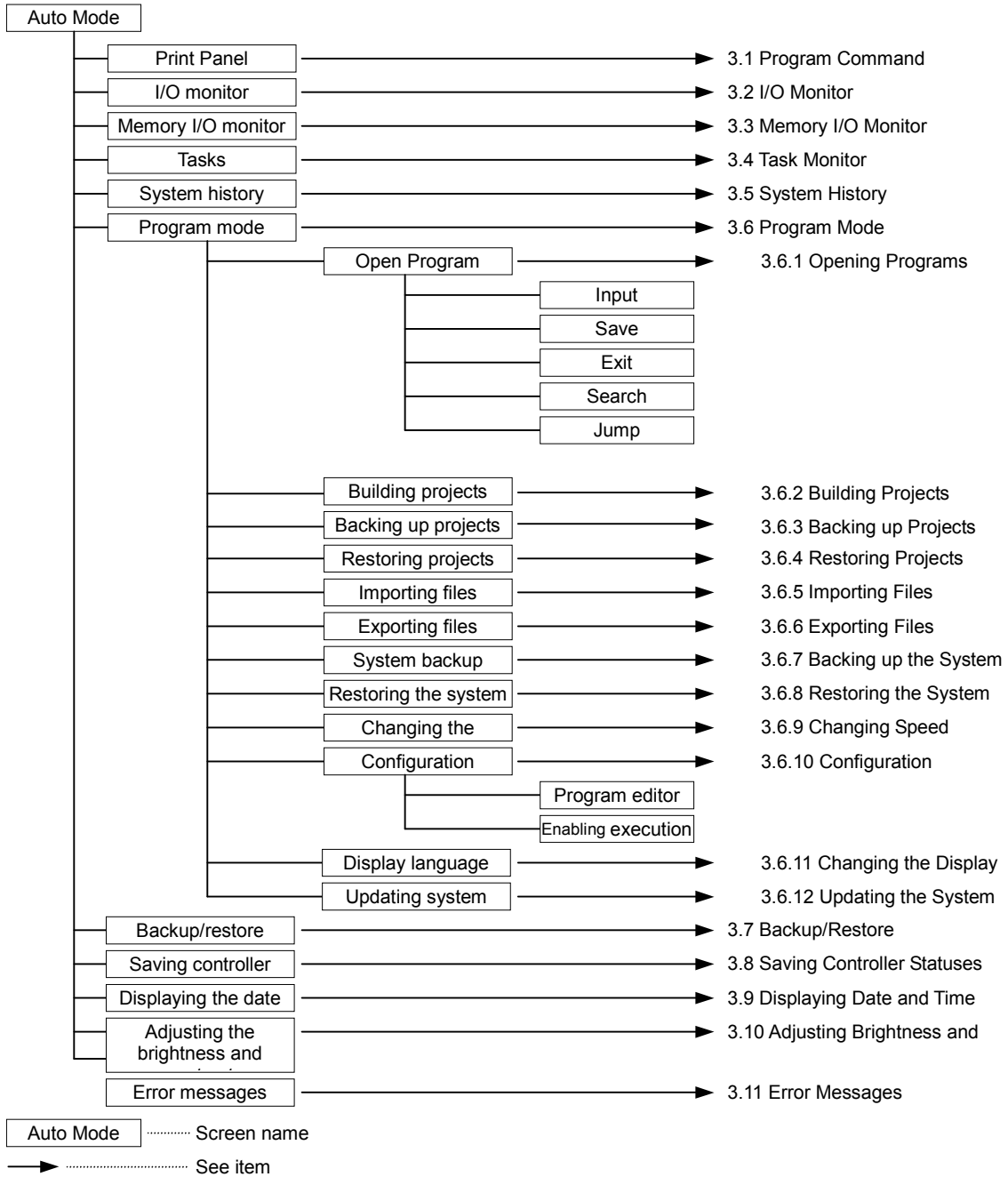

Switch the mode selector key switch to “Auto” to display the [Print] screen. Follow the description on the screen and press the <F4> key to display the [Main Menu] screen.

```
Main Menu
0 Print Panel
1 I/O Monitor
2 Memory I/O Monitor
3 Task Monitor
4 System History
5 Program Mode
6 Backup / Restore...
7 Controller Status...
8 Date / Time
9 Brightness / Contrast

Select: ↑ Go to: OK
```



TIP Menus with “...” at the end have following procedures after selecting the menu and cannot be executed only by pressing the <OK> key.

3.1 Program Command Display

This screen displays messages from the program and requests responses.

The [Print] screen appears when the mode selector key switch is switched to “Auto”.

To display the [Print] screen from the [Main Menu] screen, move the cursor to [Print Panel], and press the <OK> key.

When only a message appears

Program Example :

```
PRINT #24, "Test Print"
```

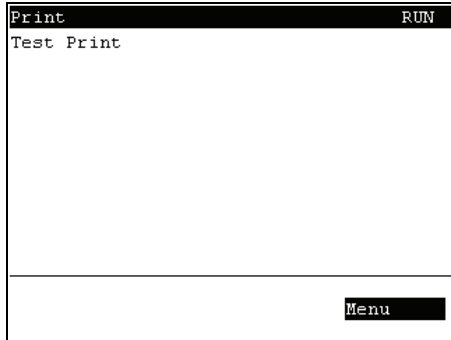

<F4> The [Main Menu] screen appears.

When a message appears and a response is requested

Program Example :

```
PRINT #24, "Test Print"
```

```
INPUT #24, a$
```

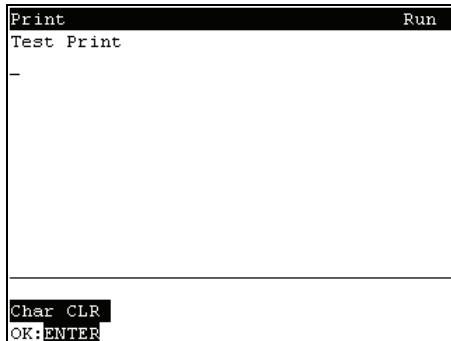

Input the response to the message at the cursor position. (Characters or numerical values)

<F1> Deletes all entered characters or numerical values.

<F4> The [Main Menu] screen appears.

3.2 I/O Monitor

This screen displays the bit status of I/O.

In the [Main Menu] screen, move the cursor to [1 I/O Monitor], and press the <OK> key.

I/O status (Inputs, bit units)

I/O Monitor		
Inputs:		
Bit#	Status	Label
0	On	Sensor0
1	On	Sensor1
2	On	
3	On	
4	On	
5	On	
6	On	
7	On	
Outputs Port Menu Next :↓ Previous :↑		

“*” (asterisk) is displayed before the label name for remote setting display to separate remote setting and I/O label.

<F1> Switches between Inputs and Outputs.

<F2> Switches the I/O bit status display (Bit units or port units).

3.3 Memory I/O Monitor

This screen displays the bit status of memory I/O.

In the [Main Menu] screen, move the cursor to [2 Memory I/O Monitor], and press the <OK> key.

Memory I/O status (bit units)

Memory I/O Monitor		
Bit#	Status	Label
0	Off	Ready
1	Off	Busy
2	Off	
3	Off	
4	Off	
5	Off	
6	Off	
7	Off	
Port Menu Next :↓ Previous :↑		

<F2> Switches the I/O bit status display (Bit units or port units).

3.4 Task Monitor

This screen displays the status of tasks.

In the [Main Menu] screen, move the cursor to [3 Task Monitor], and press the <OK> key.

```

Task Monitor
# Status Name
1 Run main
2 Run Task2
3 Run Task3
4
5
6
7
8

Line All Tasks Menu
Next :| Previous :|
    
```

When the task name is too long to display the whole name, a tilde is attached at the end of the task name as “LongTaskNa~”.

When the task is “NoPause task”, “*P” is attached at the end of the task name.

When the task is “NoEmgAbort task”, “*E” is attached at the end of the task name.

<F1> Displays the line number and task name in the program specified by the cursor.

```

Task Monitor
# Line Name
1 00007 main
2 00010 Task2
3 00017 Task3
4
5
6
7
8

Status All Tasks Menu
Next:| Previous :|
    
```

<F2> Displays the status and line number of all tasks in the program specified by the cursor.

```

Task Monitor
# Status Line # Status Line
1 Run 00008 9 Run 00021
2 Run 00013 10
3 Run 00016 11
4 12
5 13
6 14
7 15
8 16

Status Line Menu
    
```

3.5 System History

This screen displays a history of errors, operations and warnings that occurred in the past. In the [Main Menu] screen, move the cursor to [4 System History], and press the <OK> key.

Displays the item type, Number, joint #, task #, date, and time in this order from the left.

[System History] main screen

System History					
Type	Num	J#	T#	Date	Time
Event	5	0	1	10/03/06	10:29
Event	5	0	1	10/03/06	10:25
Error	1103	0	0	10/03/06	10:25
Error	1103	0	0	10/03/06	10:25
Event	127	0	0	10/03/06	10:25
Event	120	0	0	10/03/06	10:25
Event	121	0	0	10/03/06	10:22
Error	1105	0	0	10/03/06	10:22
Event	1	0	0	10/03/06	10:22

Select: ↑ | Detail Menu

<F2> Displays the details of the error specified by the cursor.

System History	
Num :4031	Type :Error
Joint :0	Task # :0
Date :10/02/06	Time :13:47
Code1 :0	Code2 :0
Function:	
Cannot execute a motion command when the motor is in the off state.	

Scroll : ↑ | Err List

3.6 Program Mode

This section indicates settings in the [Program Mode] screen.

Follow the procedure below to display the [Program Mode] screen.

- (1) In the [Main Menu] screen, move the cursor to [5 Program Mode...], and press the <OK> key.
- (2) The following screen appears.

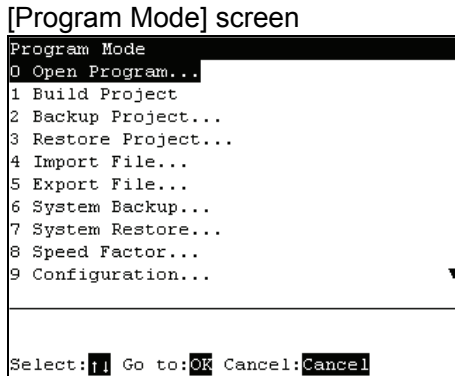

Move the cursor to the last line and press the <↓> key to display the following screen.

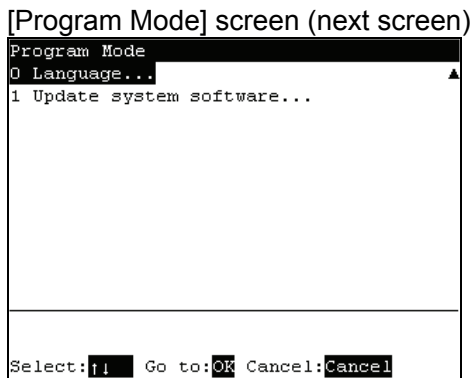

TIP Menus with “...” at the end have following procedures after selecting the menu and cannot be executed only by pressing the <OK> key.



NOTE When a password is set up, the following screen appears before displaying the [Program Mode] screen.

Enter the password (1 to 16 characters). Press the <OK> key.

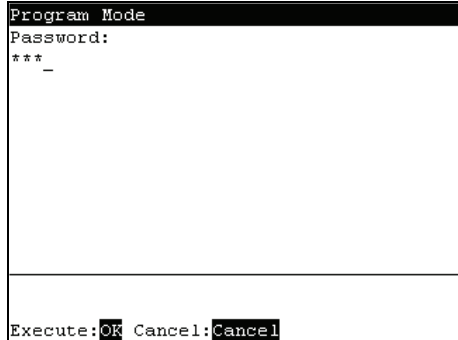

For password setting, refer to *Operation 4. Password Setup*.

3.6.1 Open Programs

- (1) In the [Program Mode] screen, move the cursor to [0 Open Program...], and press the <OK> key.

The screen that appears next differs according to the number of files that are currently saved.

When there is only one file

Select the “function” and press the <OK> key to open the file.

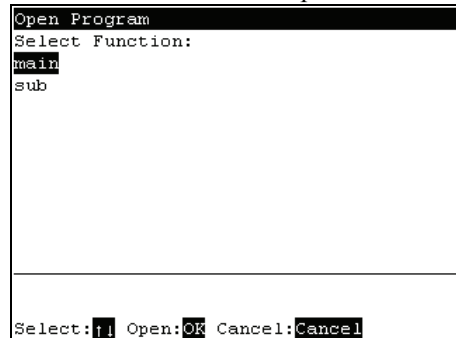

When there are two or more files

Select the file, and press the <OK> key to open the file.

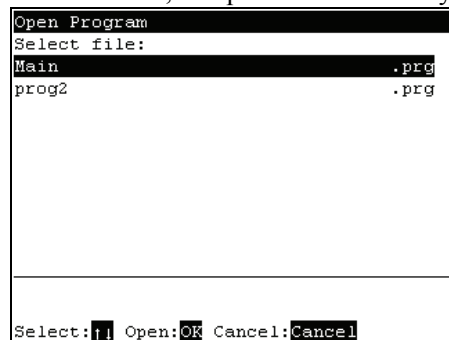

- (2) The following screen appears.

Program edit screen (example)

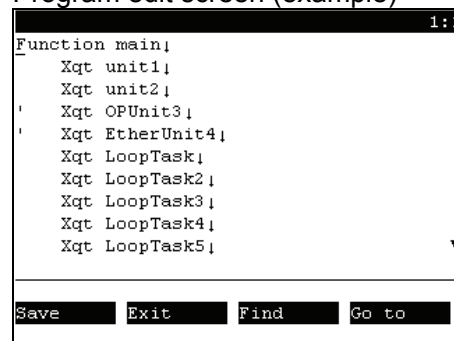

Entering programs

The character and numerical value input modes are switched according to whether the “Alph” lamp is ON or OFF.

Press the <Alph/Num> key to switch “Alph” between ON or OFF.

Alph	Mode	Key	Function
OFF	Numerical value input mode	0 to 9 – (minus) . (period)	Numerical value input
ON	Character input mode	ABC to WXYZ	Character input
		SP (space)	Space input
		a/A	Switching between lowercase and uppercase
Common		Sym	Symbol input
		CLR	Clears numerical values and text.
		Enter	Determines numerical values and characters.

Operation panel (excerpt)

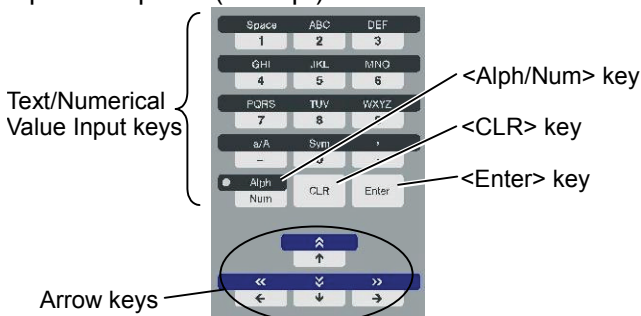

How to enter characters

Multiple characters are assigned to each button of the text/numerical value input keys. The character changes by each press of the button.

Example : When the <ABC / 2> key is pressed (when “Alph” is ON)

The character changes in order “a” → “b” → “c”.

To continue input using the same button, press the <→> key to move the cursor forward.

Example : Input “Teach 170”.

(1) Input “Teach”.

Press the <Alph / Num> key to light “Alph”.

Press the <a/A / →> key to switch to input of uppercase characters.

Press the <TUV / 8> key once.

Press the <a/A / →> key to switch to input of lowercase characters.

Press the <DEF / 3> key twice.

Press the <ABC / 2> key once. Press the <→> key to move the cursor forward.

Press the <ABC / 2> key three times.

Press the <GHI / 4> key twice.

(2) Enter a space.

Press the <Space / 1> key once.

- (3) Enter "170".
 Press the <Alph / Num> key to turn "Alph" OFF.
 Press the <Space / 1> key once.
 Press the <PQRS / 7> key once.
 Press the <Sym / 0> key once.

How to enter symbols

- (1) Press the <Alph / Num> key to light "Alph".
- (2) Press the <Sym / 0> key to display the following screen.

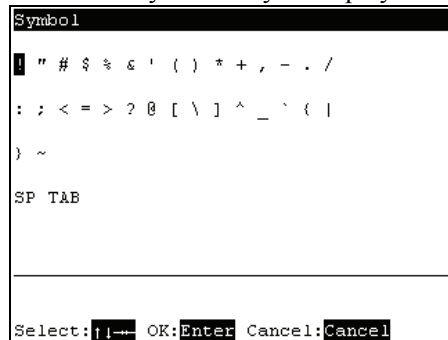

- (3) Select the symbol, and press the <Enter> key.

Entering text using key words

Candidate command statements are anticipated and displayed from text that is currently being entered. Move the cursor, select the desired command statement, and press the <Enter> key.

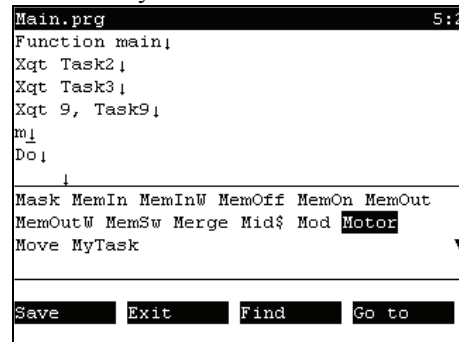

Entering text using syntax help

If you enter a space () , . = > following a specific command statement, such as "MOTOR" or "POWER", candidate characters to enter appear.

Move the cursor, select the desired character, and press the <Enter> key.

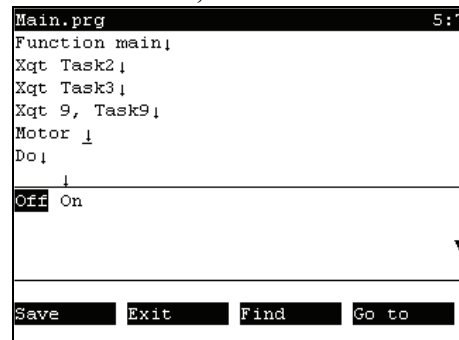

Save programs

Save programs after editing the programs.

- (1) Press the <F1> key to save the program file. The following screen appears during saving the program file.

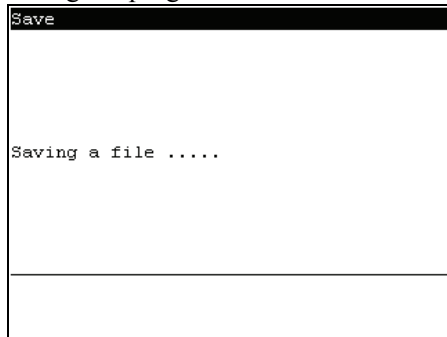

- (2) After the save ends, the screen returns to the program edit screen.

Exiting program edit



Execute the program building when the save is finished.

If not, outcome of the edit will not be reflected in the program operation.

Finish editing the program.

- (1) Press the <F2> key to exit the program file.
- (2) After the save ends, the screen returns to the program edit screen.

The following screen appears when the program file has been changed but not saved.

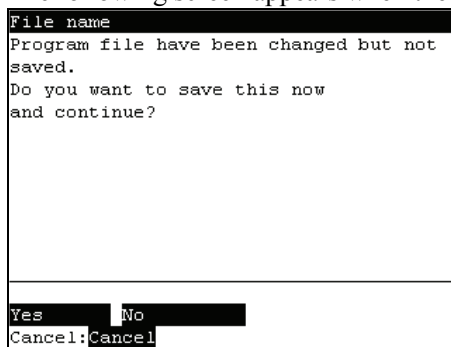

<F1> Saves the file, and returns to the program edit screen.

<F2> Returns to the [Program Mode] screen without saving the changes of the program file.

Search character strings

Search for character strings in the program.

- (1) Press the <F3> key. The following screen appears.
Enter the character string to search, and press the <Enter> key.

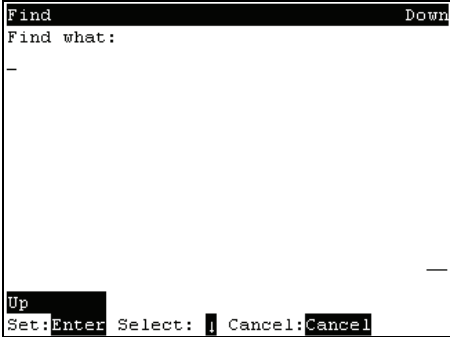

- <↓> Displays a list of search text strings.
- <F1> Changes the search order (descending, ascending).

The following screen appears during the search.

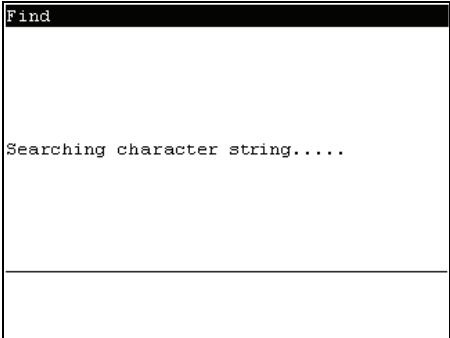

- (2) If the character string is found, the cursor moves to the start of that character string.
If the character string is not found, the cursor position does not change.

Jump

This section describes settings that can be made in the [Go to] screen.
In the program edit screen, press the <F4> key. The following screen appears.

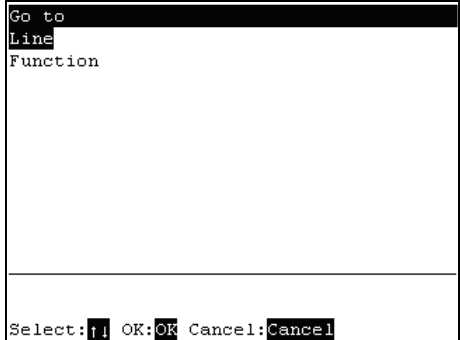

Jumping to a specified line in the program

- (1) Move the cursor to "Line", and press the <Enter> key.
- (2) The following screen appears.

Enter a numerical value at [Enter line number] to specify the line number.

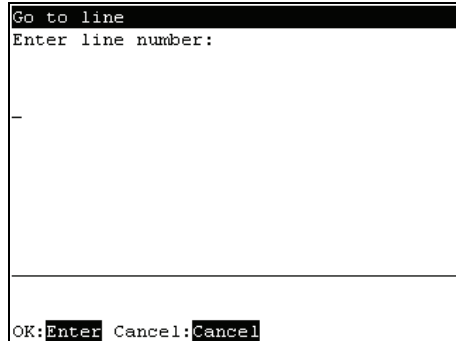

- (3) Move the cursor to the specified line.

Jumping to a "function" in the program file

- (1) Move the cursor to [Function], and press the <Enter> key.
- (2) The following screen appears.

Move the cursor to the desired "function" and press the <OK> key.



The following screen appears during execution.

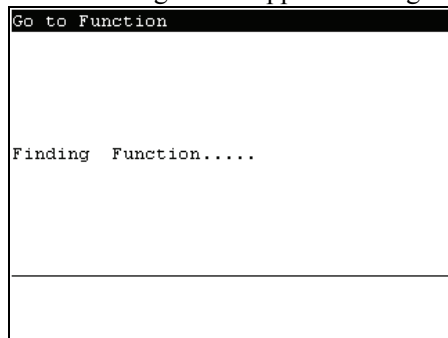

- (3) The specified "function" screen appears.

3.6.2 Building Projects

Follow the procedure below to build projects.

- (1) In the [Program Mode] screen, move the cursor to [1 Build Project...], and press the <OK> key. Building of the project is started. The following screen appears during execution.

```
Build
Starting project build .....
```

- (2) When building is successful

The following screen appears after the project building is successfully completed.

```
Build
Build complete, no errors
Select: [ ] Go to: [OK]
```

When building fails

The error message list appears.

Move the cursor to the desired error, and press the <OK> key.

```
Build
Build aborted
0 #3311 Line 1 in main2.prg.obj
Select: [ ] Go to: [OK]
```

The file with the error appears, and the error line is indicated by the cursor.

3.6.3 Backing up Projects

Backs up projects to USB memory.

- (1) Insert the USB memory into the Controller.
- (2) In the [Program Mode] screen, move the cursor to [2 Backup Project...], and press the <OK> key.
- (3) The following screen appears.

Press the <OK> key to execute the project backup.

Saves the project to the folder “\EpsonRC50\Projects” in the USB memory.

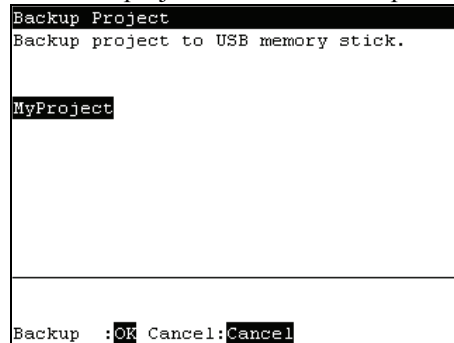

When a project of the same name exists in the USB memory, the following screen appears.

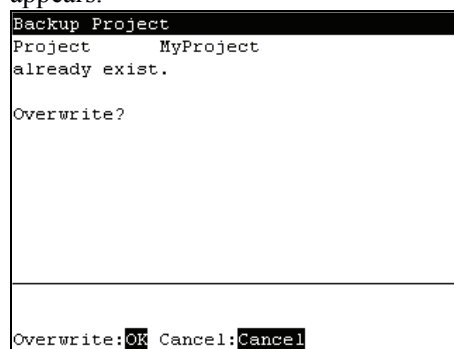

- <OK> Overwrites the project.
- <Cancel> Cancels the project backup.

3.6.4 Restore Projects

Restores projects backed up in USB memory to the Controller.

- (1) Insert the USB memory into the Controller.
- (2) In the [Program Mode] screen, move the cursor to [3 Restore Project...], and press the <OK> key.
- (3) The following screen appears. Press the <OK> key.

```
Restore
Restore project from USB memory stick.

Please press the OK key to select the
project.

OK:OK Cancel:Cancel
```

- (4) The following screen appears. Displays the project list in the folder “\EpsonRC50\Projects” in the USB memory. Move the cursor to the desired project, and press the <OK> key.

```
Restore Project
Select Project:
OPTEST
TP_Build
TestSrcpose
TPtest
TPCalibTest
Test 4MB
MyProject

Select:↑ Open:OK Cancel:Cancel
```

- (5) The following screen appears. Press the <F1> key.

```
Restore Project

/MyProject/

Ready to restore the project files.
Continue?

Yes No Cancel:Cancel
```

- (6) Executes the project restore.

3.6.5 Import Files

Imports “Prog”, “Inc” and “Pts” files in the USB memory to projects in the Controller. Only files of the same name as those that exist in projects can be imported.

- (1) Insert the USB memory into the Controller.
- (2) In the [Program Mode] screen, move the cursor to [4 Import File...], and press the <OK> key.
- (3) The following screen appears.
Move the cursor to the file to import, and press the <OK> key.

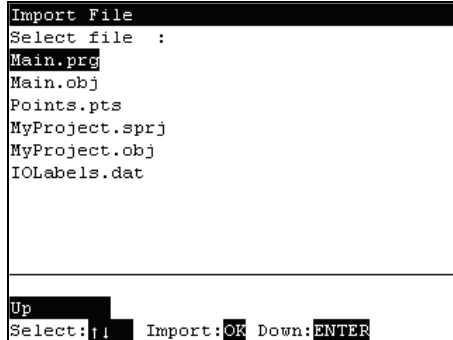

- <Enter> Displays the hierarchy one level below the selected folder.
- <F1> Displays the hierarchy one level above the selected folder.

- (4) Executes the file import.
When a file of the same name already exists, the following screen appears.

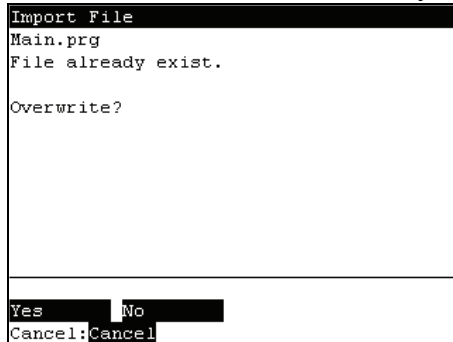

- <F1> Overwrites the file.
- <F2> Moves to the [Program Mode] screen.

3.6.6 Export Files

Exports “Prg”, “Inc” and “Pts” files in projects in the Controller to the USB memory.

- (1) Insert the USB memory into the Controller.
- (2) In the [Program Mode] screen, move the cursor to [5 Export File...], and press the <OK> key.
- (3) The following screen appears.

Move the cursor to the file to export, and press the <OK> key.

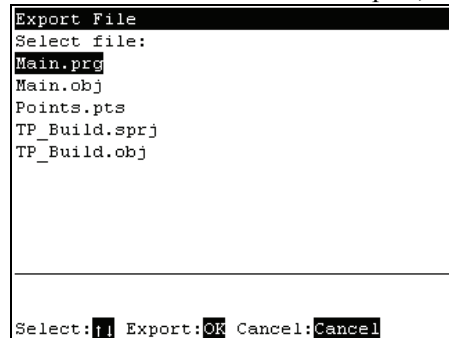

- (4) The following screen appears. Press the <F2> key.

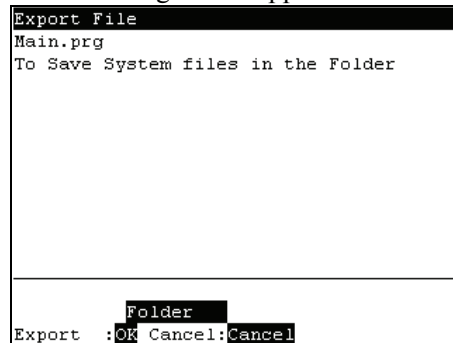

TIP When <OK> key is pressed without specifying a folder, the backup file is stored directly in the USB memory. For procedure to specify the folder, refer to (5).

- (5) The following screen appears. Move the cursor to export and press the <OK> key.



<Enter> Displays the hierarchy one level below the selected folder.

<F1> Displays the hierarchy one level above the selected folder.

- (6) The following screen appears. Press the <OK> key.

```
Export File
/EpsonRC50/Projects/MyProject/Main.prg
To Save System files in the Folder

Folder
Export :OK Cancel:Cancel
```

- (7) Executes the file export.

When a file of the same name already exists, the following screen appears.

```
Export File
Main.prg
file already exist.
Overwrite?

Yes No
Cancel:Cancel
```

- <F1> Overwrites the file.
<F2> Moves to the [Program Mode] screen.

3.6.7 Backup System

Backs up system files in the Controller to the USB memory.

- (1) Insert the USB memory into the Controller.
- (2) In the [Program Mode] screen, move the cursor to [6 System Backup...], and press the <OK> key.
- (3) The following screen appears.

Enter the file name and press the <Enter> key.

```

System Backup
Backup robot parameters to a file.
Please enter the Backup file name.

File name :
b20061003_

Set :Enter OK:OK Cancel:Cancel

```

- (4) The following screen appears. Press the <OK> key.

```

System Backup
b20061003
To Save System files in the Folder

Folder

OK:OK Cancel:Cancel

```



TIP When <OK> key is pressed without specifying a folder, the backup file is stored directly in the USB memory. For procedure to specify the folder, refer to (5).

- (5) The following screen appears. Move the cursor to the folder to save the backup data and press the <OK> key.

```

System Backup
Select Backup Folder.

S 66 20060529120843
EpsonRC50

Select: | Backup :OK Cancel:Cancel

```

- (6) The following screen appears. Press the <OK> key to execute the system backup.

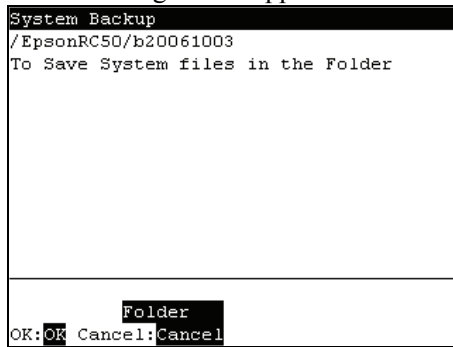

When a file of the same name already exists, the following screen appears.

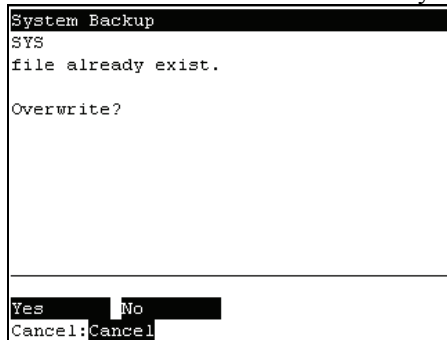

- <F1> Overwrites the file.
- <F2> Moves to the [Program Mode] screen.

- (7) After execution is completed, the following screen appears

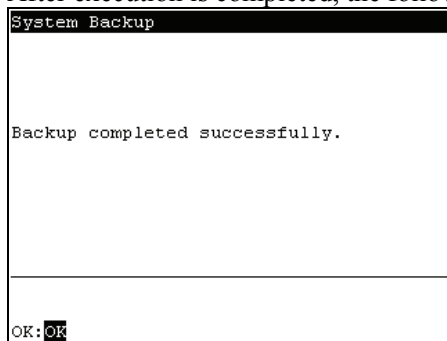

3.6.8 Restore System

Restores system files backed up in USB memory to the Controller.

- (1) Insert the USB memory into the Controller.
- (2) In the [Program Mode] screen, move the cursor to [7 System Restore...], and press the <OK> key.
- (3) The following screen appears.

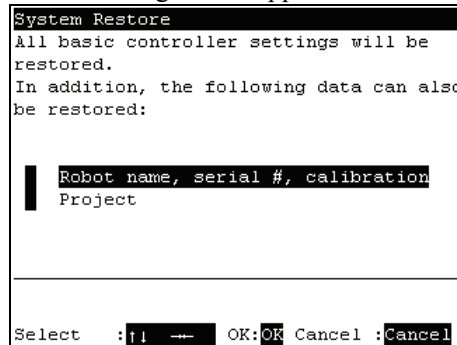

When you restore the robot name, serial number, and the calibration data with the basic Controller settings, move the cursor to [Robot name, serial #, calibration] and press the <→> key.

When you restore the project with the basic Controller settings, move the cursor to [Project] and press the <→> key.

- (4) Press the <OK> key
- (5) The following screen appears. Press the <OK> key.

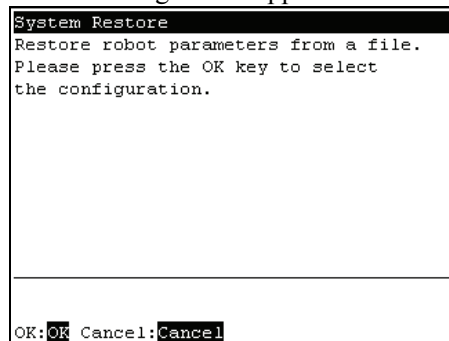

- (6) The following screen appears. Move the cursor to the desired folder. Press the <Enter> key.

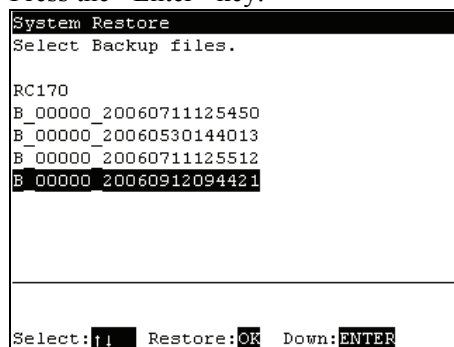

- (7) The following screen appears. Press the <F1> key to start the restore.

```
System Restore
/B_00000_20060912094421
Ready to restore system files.
Continue?

Yes No Cancel:Cancel
```

When the Controller serial number does not match the serial number of the selected Controller setting data, the following screen appears. To continue, press the <F1> key.

```
System Restore
Warning:
The serial number of the backup data
does not match the current controller
serial number.
Continue?

Yes No Cancel :Cancel
```

When the Controller system software version does not match the version of the selected Controller setting data, the following screen appears. To continue, press the <F1> key.

```
System Restore
Warning:
The version number of the backup data
does not match the current controller
version.
Continue?

Yes No Cancel :Cancel
```

- (8) After execution is completed, the following screen appears. Press the <OK> key and the Controller reboots.

```
System Restore

Restore completed successfully.

OK:OK
```

3.6.9 Changing Speed Factor

Changes the operating speed of robot motion commands (Go, Jump, Pulse commands, etc.) in the program.

- (1) In the [Program Mode] screen, move the cursor to [8 Speed Factor...], and press the <OK> key.
- (2) The following screen appears.
Enter the factor (unit: %, 1 to 100 integer) with respect to the maximum speed.
Press the <Enter> key and apply the numerical value.

```
Speed Factor
Set speed factor:
Factor:100

Default
Set :Enter OK:OK Cancel:Cancel
```

<F1> Returns the factor to its default (100).

- (3) Press the <OK> key to set the value.

3.6.10 Configuration

In the [Program Mode] screen, move the cursor to [9 Configuration...], and press the <OK> key. The following screen appears.

```
Configuration
0 Editor
1 Backup Screen

Select:1 Go to:OK Cancel:Cancel
```

Configure program editor

Set the preferences of the program editor.

- (1) In the [Configuration] screen, move the cursor to [0 Editor], and press the <OK> key.

The setup screen appears.

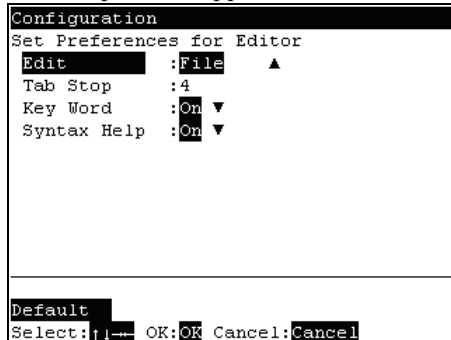

To change an item:

Move the cursor to the left column.

To change item settings:

Move the cursor to the right column.

- (2) Press the <↑> <↓> keys to move the cursor to the item and press the <→> key to move the cursor to the right to confirm the item.
Press the <↑> <↓> keys to move the cursor to change the setting.

Changing the program edit area

Select the [Edit] and select the program edit area (Function, File).

Function : Set the area to a specific “function”.

File : Set the area to the entire file.

Changing the tab width of the program editor

Select the [Tab Stop] and input the tab width (unit: character, 1 to 8).

Turning the keyword candidate display function of the program editor On/Off

Select the [Key Word] and select On/Off.

The default is “On”.

Turning the syntax help function of the program editor On/Off

Select the [Syntax Help] and select On/Off.

The default is “On”.

- (3) When a setting has been changed, be sure to press the <OK> key to save the setting. Pressing the <F1> key returns the setting to its default. The screen in step (1) shows the defaults.
Press the <OK> key and the Controller reboots.

Enable execution in main menu

Normally, the followings are set in the program mode after the password is entered.

- Project Backup / Restore
- System Backup / Restore
- File Import / Export

Items that are enabled for execution are added to the menu in the [Backup] screen. (See “Operation 3.7 Backup / Restore.”)

Follow the procedure below to enable execution in the main menu.

- (1) In the [Configuration] screen, move the cursor to [1 Backup Screen], and press the <OK> key. The following screen appears.

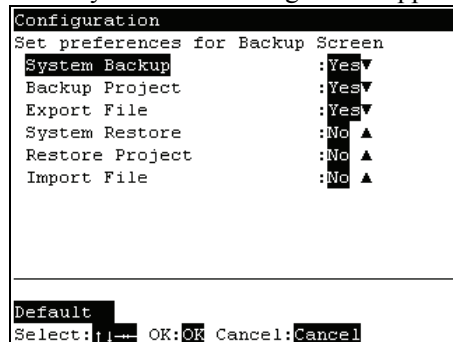

To change an item:

Move the cursor to the left column.

To change item settings:

Move the cursor to the right column.

- (2) Change the setting of each item, and press the <OK> key to save the setting.
 - Yes :Enabled
 - No :Not enabled

Pressing the <F1> key returns the setting to its default. The screen in step (1) shows the defaults.

Press the <OK> key and the Controller reboots.

3.6.11 Change Display Language

- (1) In the [Program Mode] screen, move the cursor to the last line, and press the <↓> key. The following screen appears.

Move the cursor to [0 Language...] and press the <OK> key.

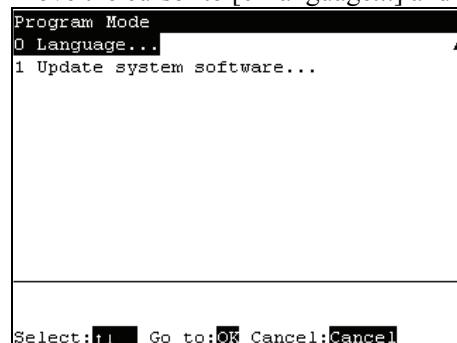

- (2) The following screen appears.

Move the cursor to the desired display language, and press the <OK> key.

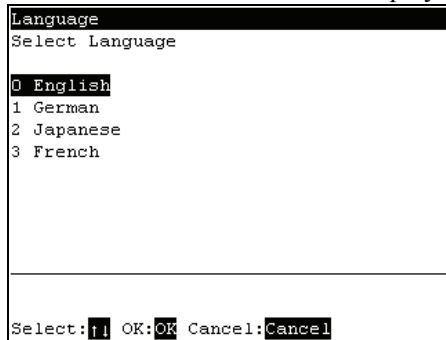

- (3) Press the <OK> key and the Controller reboots.

3.6.12 Update System Software

Updates the system software of the Controller to the system software in USB memory.

- (1) Insert the USB memory into the Controller.
- (2) In the [Program Mode] screen, move the cursor to the last line, and press the <↓> key. The following screen appears.

Move the cursor to [1 Update System Software], and press the <OK> key.

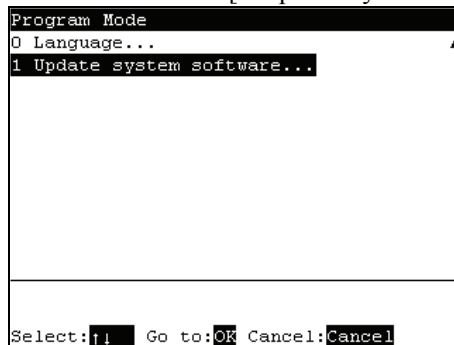

- (3) The following screen appears. Press the <OK> key.

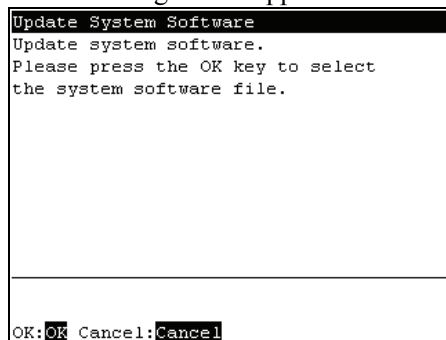

- (4) The following screen appears.

Move the cursor to the folder to update, and press the <OK> key.

```
Update System Software
Select system software file

20060531
S_0_20060531105805

Select: [ ] Update :OK Cancel:Cancel
```

<Enter> Displays the hierarchy one level below the selected folder.

<F1> Displays the hierarchy one level above the selected folder.

- (5) The following screen appears. Press the <F1> key to execute the update.

```
Update System Software

/EpsonRC50/Update/Setup.cdp

Ready to update the System Software
Continue?

Yes [ ] No [ ] Cancel:Cancel
```

- (6) After the software is updated, the following screen appears.

```
Update System Software

Updating.....

Copying OS.....
Copying the files.....
Completed
```

3.7 Backup / Restore

Normally, the following settings are made in the program mode after the password is entered:

- Project Backup / Restore
- System Backup / Restore
- File Import / Export

Items that are set as “Yes” (execution in the main menu “enabled”) at “Enabling execution in the main menu” can be set.

- (1) In the [Main Menu] screen, move the cursor to [6 Backup / Restore...], and press the <OK> key.
- (2) The following screen appears.

[Backup / Restore] screen (example)

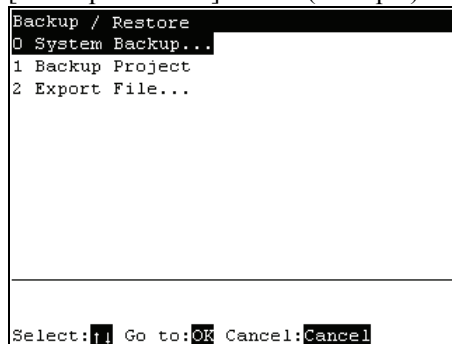

- (3) Move the cursor to the desired item, and press the <OK> key.
- (4) Set each item.
 - Project backup Operation 3.6.3 Backup Projects
 - Restoring projects Operation 3.6.4 Restore Projects
 - Importing files Operation 3.6.5 Import Files
 - File export Operation 3.6.6 Export Files
 - System backup Operation 3.6.7 Backup System
 - System restore Operation 3.6.8 Restore System

3.8 Save Controller Statuses

Indicate the procedure to save the status of the Controller to the USB memory.

- (1) Insert the USB memory into the Controller.
- (2) In the [Main Menu] screen, move the cursor to [Controller States...], and press the <OK> key. The following screen appears.

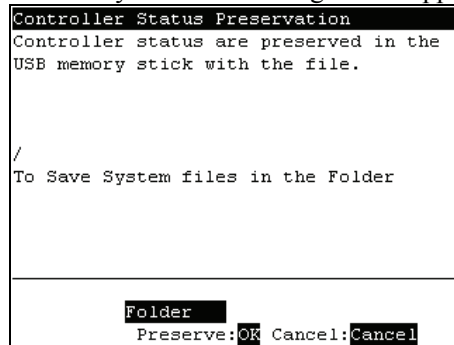

- (3) Select a folder to save the data.
The root directory is selected by default.
- (4) Press the <OK> key to save the status.

3.9 Display Date and Time

This screen displays the Controller's date and time.

- (1) In the [Main Menu] screen, move the cursor to [8 Date / Time], and press the <OK> key.
- (2) The following screen appears. Able to check the date and time.

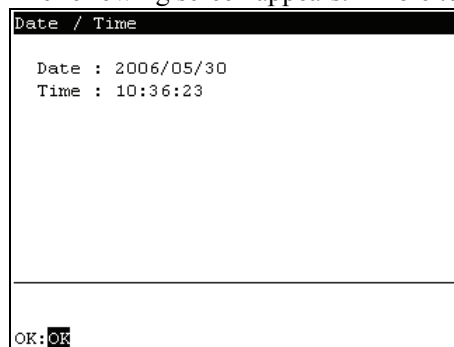

<F1> Returns to the [Main Menu] screen.

3.10 Adjust Brightness and Contrast

- (1) In the [Main Menu] screen, move the cursor to [9 Brightness / Contrast], and press the <OK> key.
- (2) The following screen appears. Press the <OK> key to apply the setting.

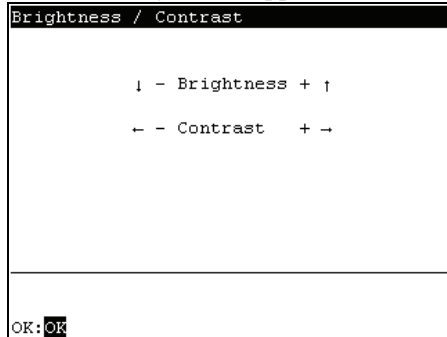

<↓><↑> These arrow keys can adjust the brightness.

<←><→> These arrow keys can adjust the contrast.

3.11 Error Messages

The following screen appears when an error occurs.

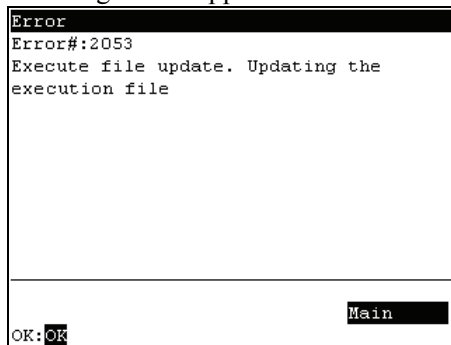

<F4> Moves to the [Main Menu].

<OK> Moves to the screen before the error occurred.

4. Password Setup

Setup a password to limit operators for the following menu.

TEACH mode [Jog&Teach]-[Maintenance]

AUTO mode [Main Menu]-[Program Mode...]

Follow the procedure below to set the password.

- (1) Turn ON the Controller.
- (2) Double click the <EPSON RC+ 5.0> icon on the desktop.
- (3) Select EPSON RC+5.0 menu-[Setup]-[Controller]-[Configuration] to display the following page.

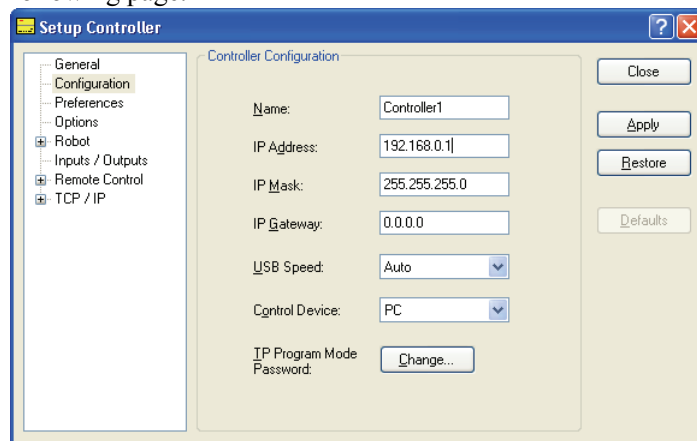

- (4) Click the <Change> button at “TP Program Mode Password.”
- (5) The following dialog appears.
Enter a password with 1 to 16 numerals from the keyboard and click the <OK> button.

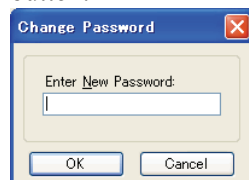

NOTE  More than one letter is assigned to each key on the TP. If characters other than numerals are used for the password, the password input will be complicated.

- (6) Click the <Apply> button and reboot the Controller.

5. Troubleshooting

Display panel is blank

- The Controller supplies DC24V.
Check that the Controller is ON.
- Check that the Controller is connected to the TP/OP connector of the Controller properly.

An Error code appears and the Robot does not operate normally

- Please refer to the error code indicated in the Controller manual.

Robot does not move by pressing the Jog key

- Execute the Motor On command to energize the Robot motor.
(Refer to Motor On in the SPEL+ Language Reference)
- Energize the Robot motor.
(Refer to SLock in the SPEL+ Language Reference)
- Short jog distance may be selected.
Check the value in the [Jog Distance] screen and change the setting to long distance if needed.
(Refer to Operation 2.3 Changing Jog Distance Data)

Operation mode does not switch from TEACH mode to AUTO mode

- Send the latch release input signal to release the latch status.

If the condition does not change after performing the countermeasure above, the unit may have suffered a breakdown.

Please contact the service center or the manufacturer.

6. Maintenance Parts List and Option

Be sure to specify the proper codes and Option when ordering maintenance parts.

Part Name		Code	Note
TP1 (with cables)	Type A	R12B120101	Cable: Circular connector (5 m)
	Type B	R12B120102	Cable: D-sub connector (5 m)
	Type C	R12B120103	Cable: Circular connector (15 m)
	Type D	R12B120104	Cable: D-sub connector (15 m)
Key		R13B060901	Mode selector key
Wall Bracket		R12B120105	Option
Conversion Kit		R12B120111	Option CK1

