

EPSON

Operator Panel OP1
Safety and Installation

Read this manual first

Rev.3

EM111P2114F

Operator Panel OP1 Safety and Installation

Rev.3

Operator Panel OP1

Safety and Installation

Rev.3

FOREWORD

Thank you for purchasing our robot products.

This manual contains the information necessary for the correct use of the Operator Panel.

Please carefully read this manual and other related manuals before installing the robot system.

Keep this manual handy for easy access at all times.

WARRANTY

The robot system and its optional parts are shipped to our customers only after being subjected to the strictest quality controls, tests, and inspections to certify its compliance with our high performance standards.

Product malfunctions resulting from normal handling or operation will be repaired free of charge during the normal warranty period. (Please ask your Regional Sales Office for warranty period information.)

However, customers will be charged for repairs in the following cases (even if they occur during the warranty period):

1. Damage or malfunction caused by improper use which is not described in the manual, or careless use.
2. Malfunctions caused by customers' unauthorized disassembly.
3. Damage due to improper adjustments or unauthorized repair attempts.
4. Damage caused by natural disasters such as earthquake, flood, etc.

Warnings, Cautions, Usage:

1. If the robot system associated equipment is used outside of the usage conditions and product specifications described in the manuals, this warranty is void.
2. If you do not follow the WARNINGS and CAUTIONS in this manual, we cannot be responsible for any malfunction or accident, even if the result is injury or death.
3. We cannot foresee all possible dangers and consequences. Therefore, this manual cannot warn the user of all possible hazards.

TRADEMARKS

Microsoft, Windows, and Windows logo are either registered trademarks or trademarks of Microsoft Corporation in the United States and/or other countries. Other brand and product names are trademarks or registered trademarks of the respective holders.

TRADEMARK NOTATION IN THIS MANUAL

Microsoft® Windows® XP Operating system

Microsoft® Windows® 2000 Operating system

Throughout this manual, Windows XP, and Windows 2000 refer to above respective operating systems. In some cases, Windows refers generically to Windows XP, and Windows 2000.

NOTICE

No part of this manual may be copied or reproduced without authorization.

The contents of this manual are subject to change without notice.

Please notify us if you should find any errors in this manual or if you have any comments regarding its contents.

INQUIRIES

Contact the following service center for robot repairs, inspections or adjustments.

If service center information is not indicated below, please contact the supplier office for your region.

Please prepare the following items before you contact us.

- Your controller model and its serial number
- Your manipulator model and its serial number
- Software and its version in your robot system
- A description of the problem

SERVICE CENTER

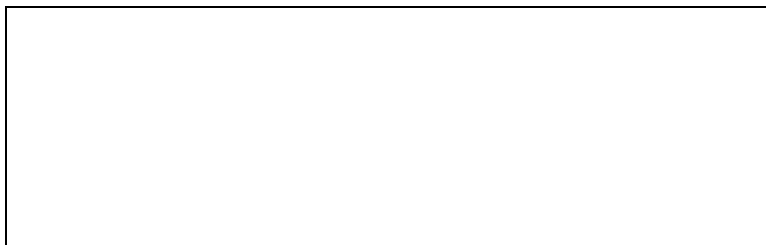

MANUFACTURER & SUPPLIER

Japan & Others

SEIKO EPSON CORPORATION

Suwa Minami Plant

Factory Automation Systems Dept.

1010 Fujimi, Fujimi-machi,

Suwa-gun, Nagano, 399-0295

JAPAN

TEL : +81-(0)266-61-1802

FAX : +81-(0)266-61-1846

SUPPLIERS

North & South America

EPSON AMERICA, INC.

Factory Automation/Robotics

18300 Central Avenue

Carson, CA 90746

USA

TEL : +1-562-290-5900

FAX : +1-562-290-5999

E-MAIL : info@robots.epson.com

Europe

EPSON DEUTSCHLAND GmbH

Factory Automation Division

Otto-Hahn-Str.4

D-40670 Meerbusch

Germany

TEL : +49-(0)-2159-538-1391

FAX : +49-(0)-2159-538-3170

E-MAIL : robot.infos@epson.de

China

EPSON China Co., Ltd

Factory Automation Division

7F, Jinbao Building No. 89 Jinbao Street

Dongcheng District, Beijing

China, 100005

TEL : +86-(0)-10-8522-1199

FAX : +86-(0)-10-8522-1120

Taiwan

EPSON Taiwan Technology & Trading Ltd.

Factory Automation Division

14F, No.7, Song Ren Road, Taipei 110

Taiwan, ROC

TEL : +886-(0)-2-8786-6688

FAX : +886-(0)-2-8786-6677

Before Reading This Manual

NOTE



Do not connect the Operator Panel OP1 to the following Robot Controllers. Connecting to the following Robot Controllers may result in malfunction of the device since the pin assignments are different.

RC420 / RC520 / RC620 / SRC5** / SRC-3** / SRC-2**



TABLE OF CONTENTS

1. Safety	1
1.1 Conventions	1
1.2 Safety Precautions	2
1.3 Emergency Stop	5
2. Installation	6
2.1 Part Names and Functions	6
2.2 Unpacking	9
2.3 Installation	10
2.3.1 Gasket	10
2.3.2 Mounting Holes	11
2.3.3 Installing Operator Panel	13
2.4 Connecting Cables	15
2.5 Teach Pendant Connection	16
2.6 Setup Display Language	17

1. Safety

1.1 Conventions

Important safety considerations are indicated throughout the manual by the following symbols. Be sure to read the descriptions shown with each symbol.

 WARNING	This symbol indicates that a danger of possible serious injury or death exists if the associated instructions are not followed properly.
 WARNING	This symbol indicates that a danger of possible harm to people caused by electric shock exists if the associated instructions are not followed properly.
 CAUTION	This symbol indicates that a danger of possible harm to people or physical damage to equipment and facilities exists if the associated instructions are not followed properly.

1.2 Safety Precautions

For details of Safety, refer to the User’s Guide 2. Safety. Please read and understand the chapter before using the robot system.



WARNING

- Only trained personnel should design and install the robot system. Trained personnel are defined as those who have taken robot system training and maintenance training classes held by the manufacturer, dealer, or local representative company, or those who understand the manuals thoroughly and have the same knowledge and skill level as those who have completed the training courses.

- Only authorized personnel who have taken the safety training should be allowed to execute teaching or calibration of the robot system. The safety training is the program for industrial robot operator that follows the laws and regulations of each nation. The personnel who have taken the safety training acquire knowledge of industrial robots (operations, teaching, etc.). The personnel who have completed the robot system-training classes held by the manufacturer, dealer, or locally incorporated company are allowed to maintain the robot system.

- Only authorized personnel who have taken the safety training should be allowed to maintain the robot system. The safety training is the program for industrial robot operator that follows the laws and regulations of each nation. The personnel who have taken the safety training acquire knowledge of industrial robots (operations, teaching, etc.), knowledge of inspections, and knowledge of related rules/regulations. The personnel who have completed the robot system-training and maintenance-training classes held by the manufacturer, dealer, or locally incorporated company are allowed to maintain the robot system.



WARNING

- Immediately press the EMERGENCY STOP switch whenever you suspect any danger.

The Operator Panel is equipped with an EMERGENCY STOP switch. Before operating the Operator Panel, make sure that the EMERGENCY STOP switch on the Operator Panel functions properly. Operating the Operator Panel when the switch does not function properly is extremely hazardous and may result in serious bodily injury and/or serious damage to the equipment, as the switch cannot fulfill its intended function in an emergency.



WARNING

- Be sure to connect the cables between the Controller and the Operator Panel properly. Do not allow unnecessary strain on the cables. (Do not put heavy objects on the cables. Do not bend or pull the cables forcibly.) The unnecessary strain on the cables may result in damage to the cables, disconnection, and/or contact failure. Damaged cables, disconnection, or contact failure is extremely hazardous and may result in electric shock and/or improper function of the system. Do not use the cables near heat or fire.



CAUTION

- Do not shock the Operator Panel physically or place any object on Operator Panel. A liquid crystal display is used for the Operator Panel display. If the display is damaged, liquid crystal may leak out. Liquid crystal is harmful. If it sticks on your skin or clothes, immediately wash your skin and clothes thoroughly with clean water and soap immediately.
- The Operator Panel must be used within the environmental conditions described in this manual. This product has been designed and manufactured strictly for use in a normal indoor environment. Using this product in the environment that exceeds the conditions may not only shorten the life cycle of the product but also cause serious safety problems.



CAUTION

- Do not disassemble, repair, or modify the Operator Panel by yourself. Improper disassembly, repair, or modification of the Operator Panel may cause not only improper function of the robot system but also serious safety problems.
- Be sure to turn OFF the Controller before connecting and disconnecting cables. Connecting or disconnecting the cables with the power ON may result in malfunction of the robot system.

1.3 Emergency Stop



WARNING

- Immediately press the EMERGENCY STOP switch whenever you suspect any danger.

The Operator Panel is equipped with an EMERGENCY STOP switch. Before operating the Operator Panel, make sure that the EMERGENCY STOP switch on the Operator Panel functions properly. Operating the Operator Panel when the switch does not function properly is extremely hazardous and may result in serious bodily injury and/or serious damage to the equipment, as the switch cannot fulfill its intended function in an emergency.

Furthermore, the EMERGENCY STOP switch does not function when nothing is displayed on the Operator Pendant screen for the disconnection of the Operator Pendant to the Controller.

Press the EMERGENCY STOP switch to stop the program execution, and turn OFF the robot axis motors. The program, pause data and other data will not be destroyed. When the EMERGENCY STOP switch is pressed, the Emergency Stop state is held both mechanically and electrically.

To resume operation, follow the procedure below to reset the emergency stop state.

How to Reset an Emergency Stop State

- (1) Remove the cause of the Emergency Stop, and make sure that the robot can be operated safely when robot operation is resumed.
- (2) Release the EMERGENCY STOP switch. To release a mechanical hold, turn the EMERGENCY STOP switch to the right.
- (3) Display the program execution screen and touch the Reset  button.

When the Emergency Stop is released, the “EMERGENCY STOP” on the Operator Panel Program Execution Screen turns OFF (displays ).

2. Installation

2.1 Part Names and Functions

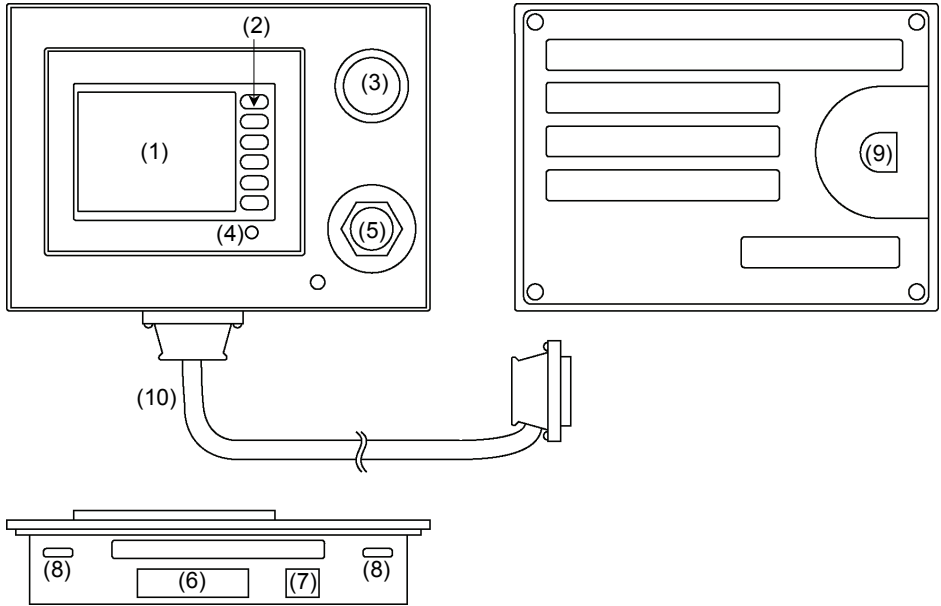

(1) Touch-sensitive LCD

This screen displays various information, and is used for automatic operation, data entry, and other operations.

 <p>WARNING</p>	<ul style="list-style-type: none"> ■ When the backlight of the touch-sensitive LCD goes out, the screen turns completely black and you can no longer see what is on the screen. The touch switches, however, are enabled. When nothing is displayed on the LCD screen even though the power LED is ON, the backlight may have gone out. Stop to use it immediately and repair the Operator Panel.
--	--

(2) Function switches

These switches are used for entering data from the Operator Panel.

(3) EMERGENCY STOP switch

This switch is for Emergency Stop. When this switch is pressed, the Emergency Stop state is held both mechanically and electrically. When an emergency stop is performed, the motor for each manipulator axis turns OFF and the robot stops immediately.

For details on how to release an Emergency Stop, refer to *1.3 Emergency Stop*.

 <p>WARNING</p>	<ul style="list-style-type: none"> ■ Immediately press the EMERGENCY STOP switch whenever you suspect any danger. The Operator Panel is equipped with an EMERGENCY STOP switch. Before operating the Operator Panel, make sure that the EMERGENCY STOP switch on the Operator Panel functions properly. Operating the Operator Panel when the switch does not function properly is extremely hazardous and may result in serious bodily injury and/or serious damage to the equipment, as the switch cannot fulfill its intended function in an emergency.
--	---

(4) Power LED

This LED lights (green) when the controller's power switch is turned ON.

2. Installation

(5) Teach Pendant connector (Bypass Plug)

This connector is for connecting the optional Teach Pendant TP1 for Robot Controller RC170/RC180.

When the Teach Pendant does not need to be connected, connect the Bypass Plug. The robot status will be the Emergency Stop state unless the Teach Pendant or Bypass Plug is connected.

 WARNING	<ul style="list-style-type: none">■ To ensure that the dust and drip-proofing function properly, be sure to attach the Bypass Plug when the Teach Pendant is not connected. Make sure to secure the Teach Pendant connect or the Bypass Plug.
	<ul style="list-style-type: none">■ You cannot connect the D-sub connector cable of TP1. Use the circular connector cable.

(6) Controller connector

This connector is connects the cable from the Operator Panel to the Controller.
(D-Sub 25-pin)

(7) HCOM connector

This connector is for connecting the high-speed communications connector.
(RJ45)

(8) Mounting metal hasp

These metal hasps are for installing the Operator Panel on a panel.
2 holes both at top and bottom (total 4 locations)

(9) TOOL connector

This connector is for connecting the communications cable to change the display firmware.

(10) OP1 cable

Connects the straight connector to the Operator Panel and right angle connector to the RC170.

Secure the connector on the RC170 side with hexagon head screws. The shape of hexagon head screw is different according to the shipment time. (with or without single slot).

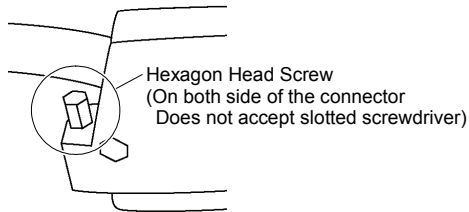

RC170 Side Connector

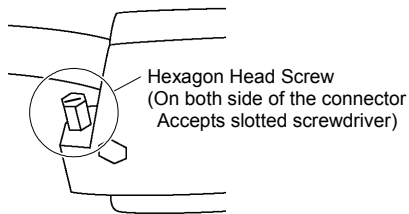

RC170 Side Connector

2.2 Unpacking

OP1	1 unit
Mounting metal hasp	4 units
Connection cable (3 m)	1 unit
Bypass Plug (install on body)	1 unit

2.3 Installation

2.3.1 Gasket

Applicable model: ST400-WP01

Even in environment that do not require drip-proofing, be sure to use the gasket (accessory provided with OP1). Install the Operator Pendant on a flat, level surface with the display facing down, and attach the gasket (provided) into the front bevelled groove from the rear.

Precautions When Handling the Gasket

- Before you install the Operator Panel, make sure that the gasket is attached to the Operator Panel.
- Gasket that is used for long periods of time or once has been installed on the panel is scratched or dirty, and may not qualify IP65 dust-proofing and drip-proofing performance. Replace the gasket periodically or when obvious scratches or dirt is seen.
- Do not insert the seams of the gasket at the corners of the Operator Panel. Inserting the seams of the gasket at the corners of the Operator Panel may cause a tensile force to the seams and the gasket may be torn.
- To ensure stable dust-proof and drip-proof, attach the gasket so that its seams come approximately 50 mm right or left to the middle of product bottom side.

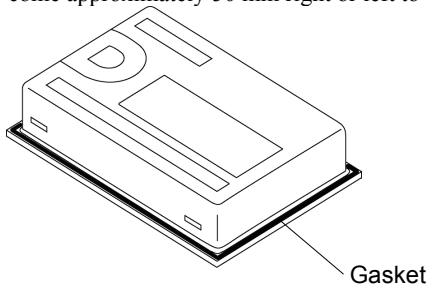

2.3.2 Mounting Holes

Machine the mounting part. For details, refer to *OP1 manual 2.3.3 Panel Cutout Dimensions*.

- Prepare the gasket and mounting metal hasps to install the Operator Panel.
- To ensure drip-proof performance, install the Operator Panel on a flat surface free of warping, scratches and unevenness. Attaching a stiffening plate is effective to prevent warping.
- The allowable panel thickness range is from 1.6 to 5.0 mm. Choose a panel thickness taking the strength of the panel into consideration.

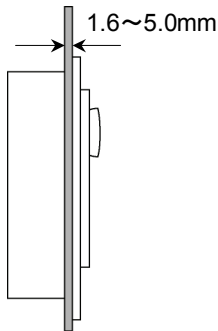

- To make it easier to maintain, operate and ventilate the Operator Panel, allow at least 100 mm space between the Operator Panel and surrounding structures and parts.

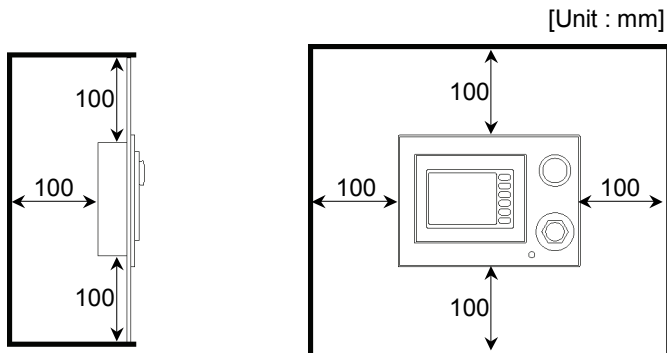

2. Installation

- Use the Operator Panel within the operating ambient temperature range of 5 to 40 degC and operating ambient humidity range of 20 to 80%. The Operator Panel may malfunction if it is used outside of these ranges. (The operating ambient temperature range applies to both inside the panel and display screen side.)

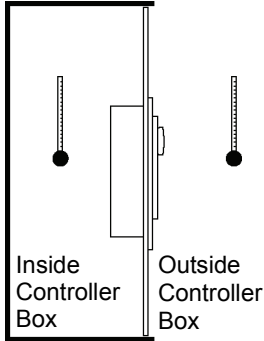

- Prevent the Operator Panel from overheating due to heat generated by other equipment.
- The Operator Panel is designed for vertical installation. It can also be installed at an angle. However, in this case, limit the angle of tilt from the vertical to 30 deg.

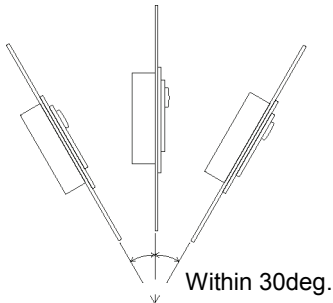

- If the Operator Panel is installed at an angle of tilt exceeding 30 deg, take measures, such as forced air cooling, to prevent the operating ambient temperature from exceeding 40 degC.
- Do not install the Operator Panel horizontally.

2.3.3 Installing Operator Panel

- (1) Set the Operator Panel into the panel cutout from the front.

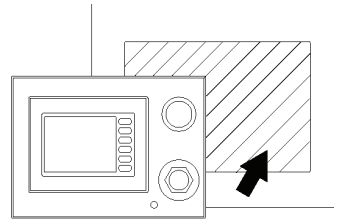

- (2) Insert the hook of the mounting metal hasps into the four mounting holes at the top and bottom of the Operator Panel.

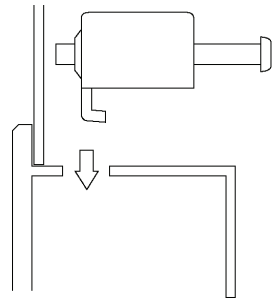
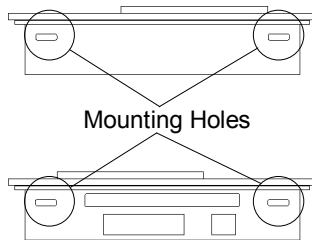

- (3) Slide the mounting metal hasps towards the rear.

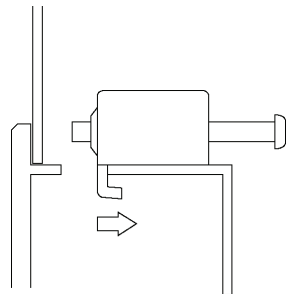

2. Installation

- (4) Secure the screws of the mounting metal hasps.

Tighten the four screws slowly, in an even, crisscross pattern.

Overtightening the screws may damage the Operator Panel.

To ensure drip-proof performance, the appropriate tightening torque is 0.5 Nm.

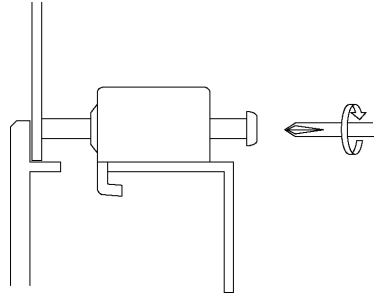

NOTE Check the tightening torque again approximately 10 minutes after tightening the screws.

2.4 Connecting Cables



WARNING

- Be sure to connect the cables between the Controller and the Operator Panel properly. Do not allow unnecessary strain on the cables. (Do not put heavy objects on the cables. Do not bend or pull the cables forcibly.) The unnecessary strain on the cables may result in damage to the cables, disconnection, and/or contact failure. Damaged cables, disconnection, or contact failure is extremely hazardous and may result in electric shock and/or improper function of the system. Do not use the cables near heat or fire.



CAUTION

- Be sure to turn OFF the Controller before connecting and disconnecting cables. Connecting or disconnecting the cables with the power ON may result in malfunction of the robot system.

- (1) Turn OFF the Controller.
- (2) Disconnect the bypass plug from the Controller.
- (3) Connect the right angle connector of the OP1 cable to the Controller, and secure it with hexagon head screws.

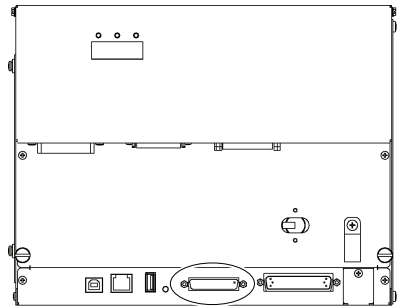

- (4) Connect the straight connector to the Controller connector of the Operator Panel, and secure it with fitting screws.

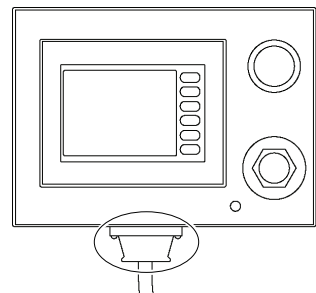

2.5 Teach Pendant Connection

- (1) Disconnect the Bypass Plug connected to the Operator Panel.
- (2) Connect the connector of the Teach Pendant to the Operator Panel and secure it tightly.

NOTE



Make sure to screw in the connector tightly to ensure dust-proof and drip-proof performance.

- (3) Make sure that the Teach Pendant starts up.
- (4) Make sure that the EMERGENCY STOP switch of the Teach Pendant operates.

NOTE



When nothing is connected to the TP/OP port of the Controller, the Controller status will be Emergency Stop status. Connect the bypass plug when the Teach Pendant or the Operator Panel is not connected.

NOTE



Connect and disconnect of the Teach Pendant is available when the Controller in ON.

Make sure to disconnect while the Controller power in OFF.

2.6 Setup Display Language

If the bottom right of the screen (operator firmware version display area) is touched while the Startup screen is displayed, the screen for setting up the Operator Panel appears.

When you finished the setup, touch the <OK> button at the bottom right of the screen. To cancel the setup and display the original state, touch the <Cancel> button at the bottom left of the screen.

Startup screen

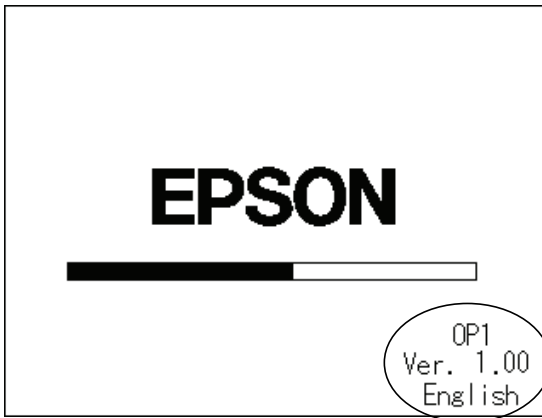

Setup screen

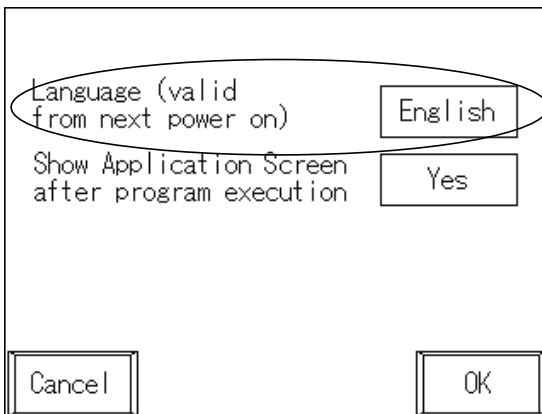

2. Installation

Language (Valid from next power on)

This item switches the display language for each of the screens. Each touch of the language display area successively switches the display language in the following order: English → Japanese → German → French→ Simplified Chinese* →Traditional Chinese*. The language set here is only for the titles, etc. that are displayed in each screen. To display text strings that are issued in the system history or by the Print command correctly, an Operator Panel configured with the appropriate code pages** must be used.

The settings become valid when the system is next started up.

The initial setting at shipment from the manufacturer is English.

* Simplified Chinese and Traditional Chinese are available with OP1 Ver.1.10 or later.

** For details on code pages, refer to *OP1 manual 5.3 About Display Language*.